

MC6100 SERIES

BRINGING THE ULTIMATE HIGH SPEED
CUTTING PERFORMANCE

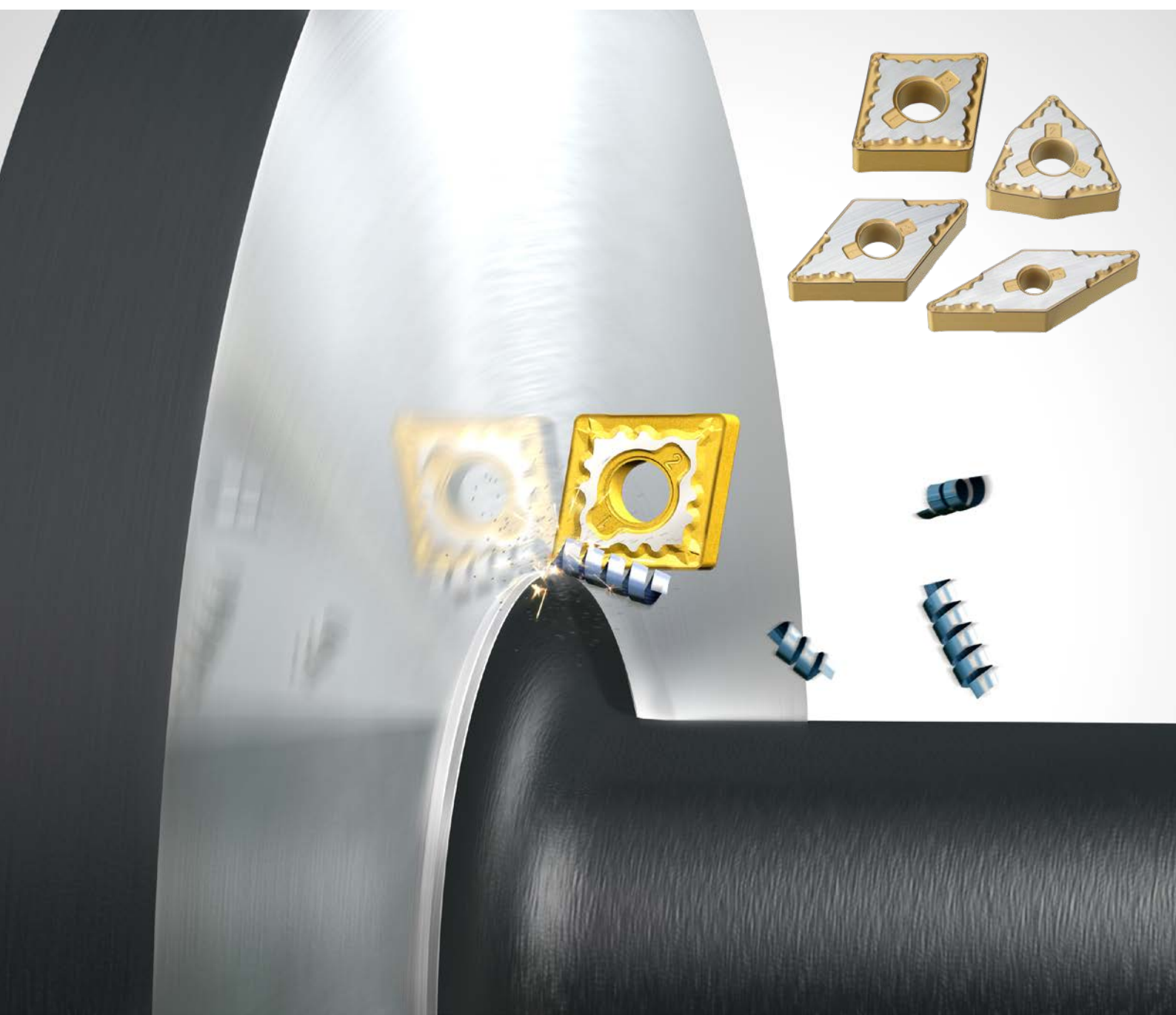

MC6100 SERIES

CVD COATED GRADE FOR STEEL TURNING

Dramatic increase in stability and wear resistance, enabled by utilising the improved coating adhesion and crystal orientation technology.

MC6115

For high speed turning



MC6125

First recommendation for a wide range of applications



MC6135

For fracture resistance



"SUPER" NANO TEXTURE TECHNOLOGY

The standard Nano Texture Technology has been improved and developed to be an industry leading standard for crystal growth of Al_2O_3 coatings. This Super Nano Texture Technology increases tool life and wear resistance due to the process that creates fine, dense crystal growth.

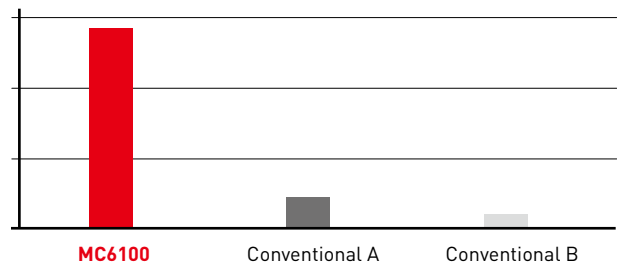
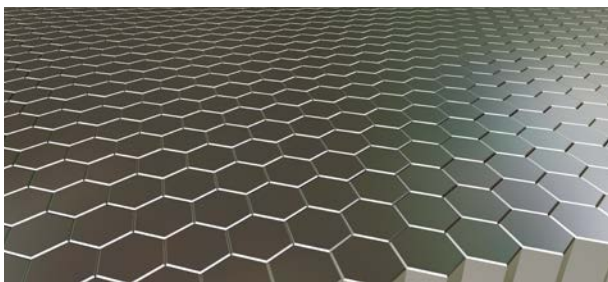

CRYSTAL ORIENTATION

(Image)

The ratio of Al_2O_3 crystal grains with the same orientation



Conventional CVD inserts

Grain size and growth direction are uneven.

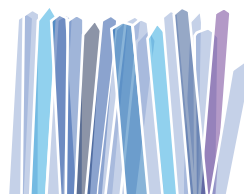

Nano Texture

Uniformity of the grain size and growth direction has improved.



„Super“ Nano Texture

Uniformity of the growth direction has drastically improved.

MC6100 SERIES

PROTECTION AGAINST SUDDEN FRACTURING

STRENGTHENED CHIPPING RESISTANCE

Cracks that occur during unstable machining are prevented due to the relaxing of the tensile stress in the coating. MC6100 series has an 80 % reduction in coating tensile stress compared to conventional CVD inserts.

RELAXING THE TENSILE STRESS

Impact stress during machining

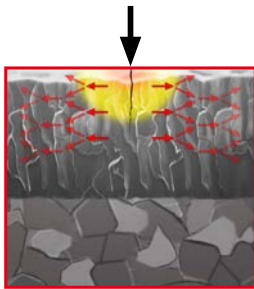

Reduced tensile stress

MC6100 Series

MC6100 series has a much lower level of stress than conventional CVD coatings due to the surface treatment. This divides the force of impacts during machining and protects from sudden fracturing.

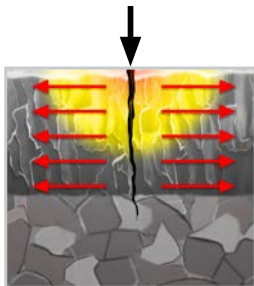

Large tensile stress

Conventional CVD inserts

Cracks are generated in the surface of coatings during machining. They propagate through the coating into the substrate due to the large tensile stress in the coating structure. This creates one of the main causes of sudden insert breakage.

SUPER-TOUGH-GRIP

The Super Tough-Grip layer has finer crystal grains that enhance the strength of the adhesion between the coating layers.

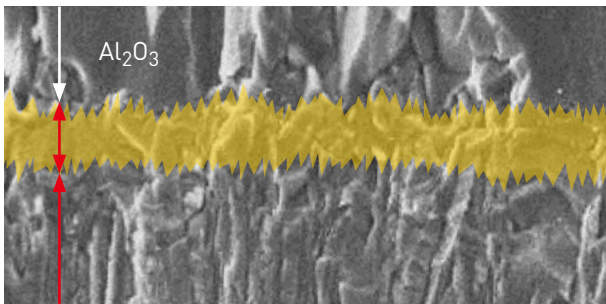

(Image)

Adhesion strength evaluation*

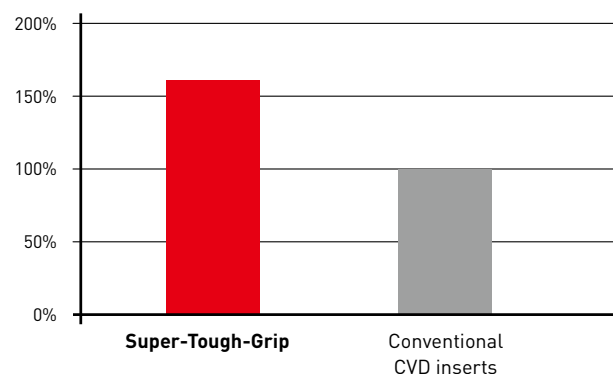

*Adhesion strength measurement is obtained from a scratch test that records the force needed to peel the coating layers.

MC6115

MC6115 IMPROVES HIGH SPEED MACHINING AND PROCESS EFFICIENCY WITH A DRAMATIC INCREASE IN RESISTANCE TO WEAR AND HEAT

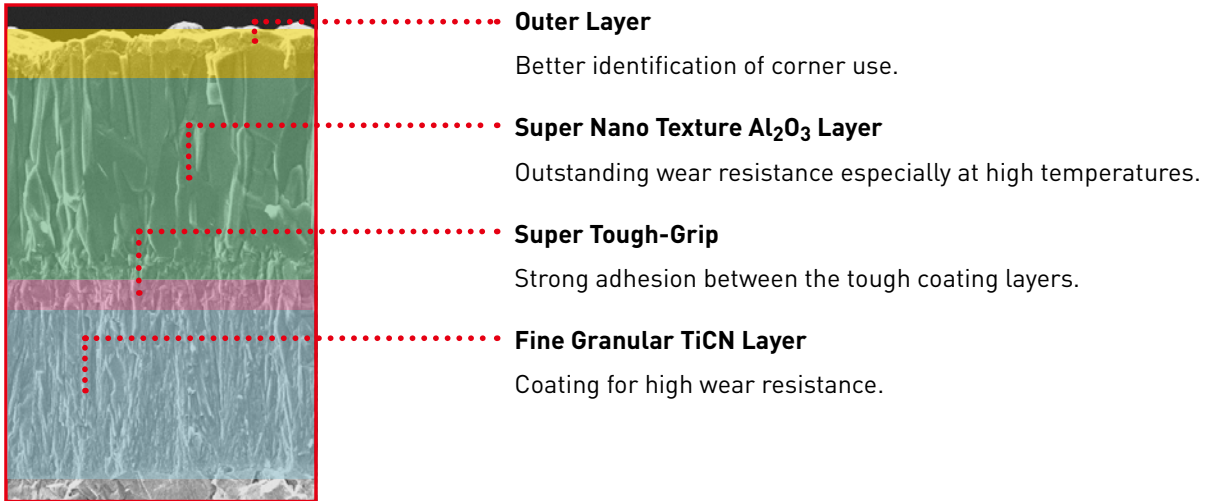

IMPROVED OUTER COATING (LAYER)

The outer layer of MC6115 restricts chip welding thereby improving the dimensional accuracy and surface roughness of components. This also enables easy recognition of whether the insert corner can continue machining.

EXAMPLE WHEN MACHINING DIN 20MNCr5

MACHINING DIN 20MNCr5: COMPARISON OF WEAR RESISTANCE

Material	DIN 20MnCr5 170HB
Insert	CNMG120408-MH
Vc (m/min)	200
f (mm/rev)	0.3
ap (mm)	1.5
Cutting mode	Dry cutting

Results

When comparing the high edge strength MH breaker with a conventional low resistance chipbreaker, it shows that MC6115 accomplishes both high welding and wear resistance.

AFTER 2 MINUTES OF MACHINING CHROME STEEL



**MC6115
MH Breaker**



Conventional CVD insert

MC6125

FIRST RECOMMENDED GRADE FOR STEEL TURNING
INCREASING TOOL LIFE WITH STABLE PERFORMANCE
OVER A WIDER RANGE OF APPLICATIONS

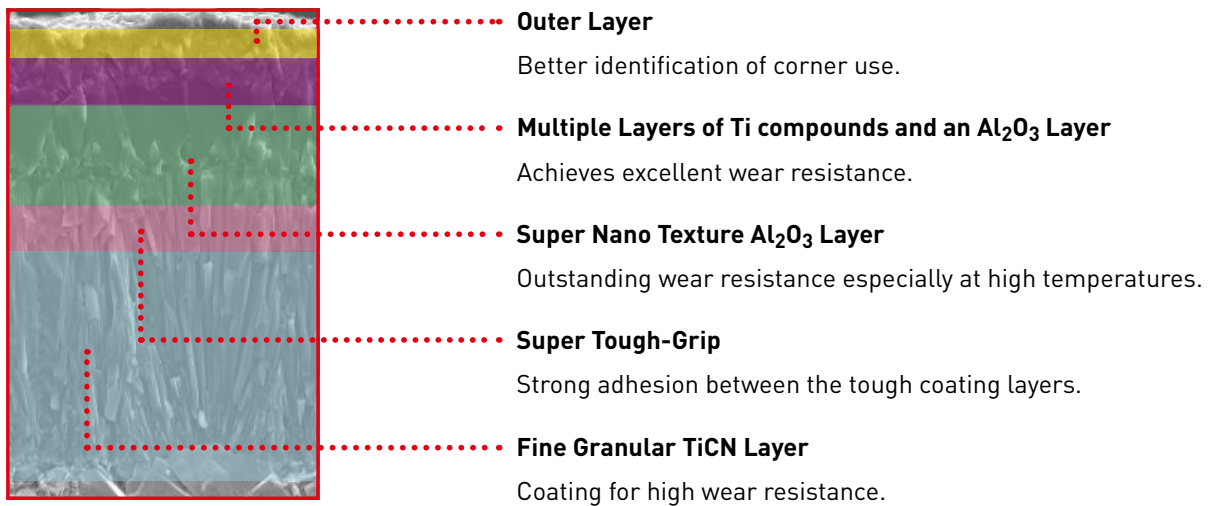

SPECIAL SMOOTH SURFACE TREATMENT

MC6125 uses a new surface treatment at the cutting edge for increased stability. Additionally, the single layers are made with a special smoothing preparation that provides greater adhesion to enable a wider range of applications.

EXAMPLE WHEN MACHINING C45

MACHINING S45C: COMPARISON OF WEAR RESISTANCE

Material	C45
Insert	CNMG120408-MH
Vc (m/min)	200
f (mm/rev)	0.3
ap (mm)	1.5
Cutting mode	Wet cutting

Results

The surface treatment has improved stability and provided longer tool life.

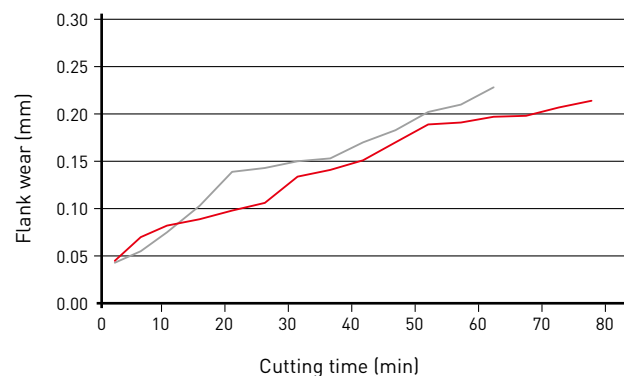

MC6135

OPTIMAL VERSATILITY FOR MACHINING CONTINUOUS THROUGH TO INTERMITTENT APPLICATIONS

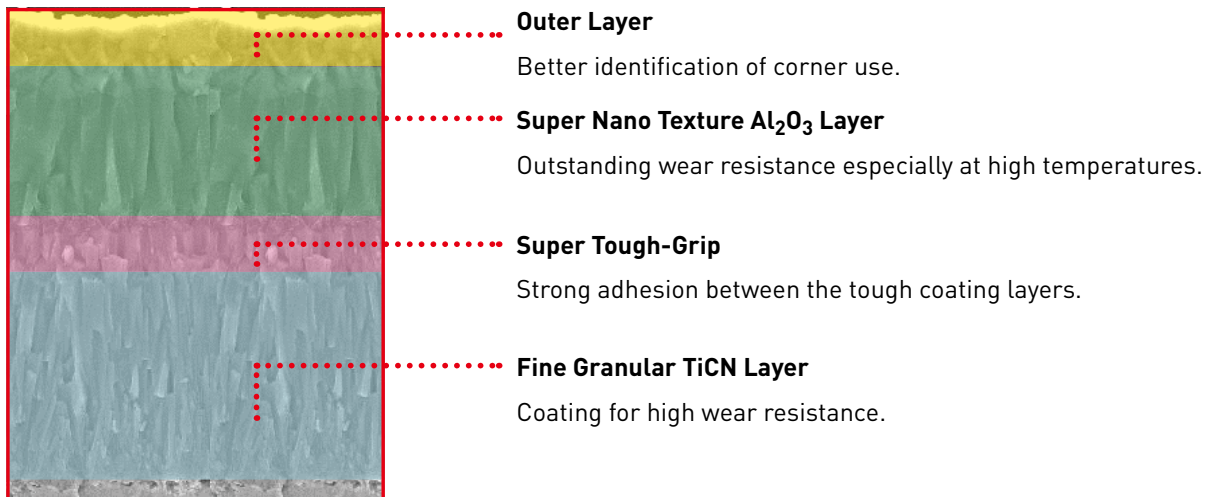

THINNER COATINGS OPTIMISED FOR GENERAL PURPOSE MACHINING

Industry-leading crystal orientation control technology enables thinner but still impact-resistant coatings provide improved chipping and wear resistance which is optimal for general-purpose use. [50 % thinner compared to our conventional coating].

MACHINING DIN 41CRM04: COMPARISON OF TOUGHNESS DURING INTERRUPTED CUTTING

MC6135 shows high stability even during interrupted cutting and can be used over a wide area of applications.

Material	DIN 41CrMo4
Insert	CNMG120408-00
Vc (m/min)	200
f (mm/rev)	0.35
ap (mm)	2.5
Cutting mode	Wet cutting
Results	Pre-set tool life limit or until damage deteriorates the performance.

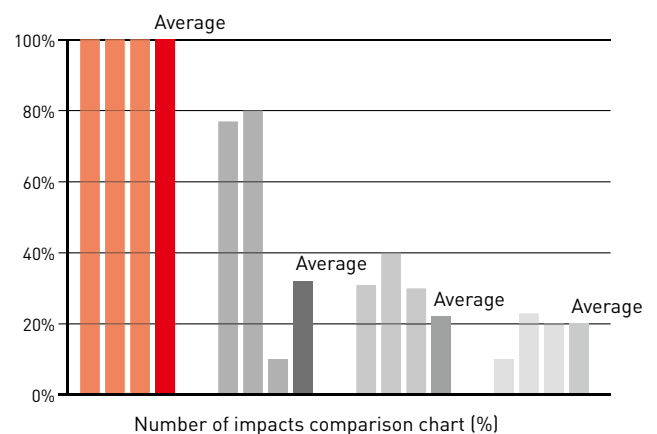

MC6100 SERIES

SELECTION CRITERIA AND APPLICATION RANGE

Material	Cutting mode	Grade	P	CVD
P Steels	Continuous cutting	Low	MC6115	
	↑ ↓	Medium	MC6125	
		High	MC6035	
		Interrupted cutting	MC6135	
				P10
			P20	
			P30	
			P40	
			P50	



FPH CHIPBREAKER

FOR LOW DEPTHS OF CUT AND HIGH FEED FINISHING

The combination of a positive land cutting edge shape and a two-stage protrusion optimises chip generation at low depths of cut, high feed conditions, thereby reducing machining times.

Main Convex

Provides consistent chip curling effect even for the thicker chips produced at high feed rates.

Positive Land

Optimum balance of sharpness and fracture resistance.

Sub Convex

Enables good chip breaking when copy turning with varying depths of cut.

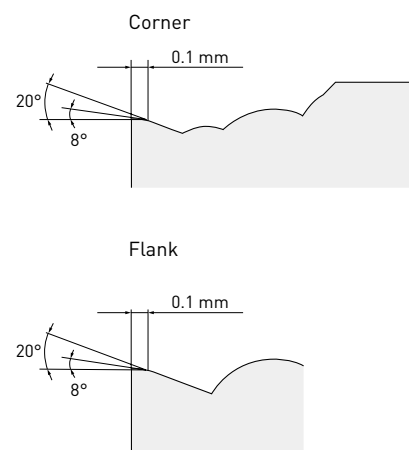
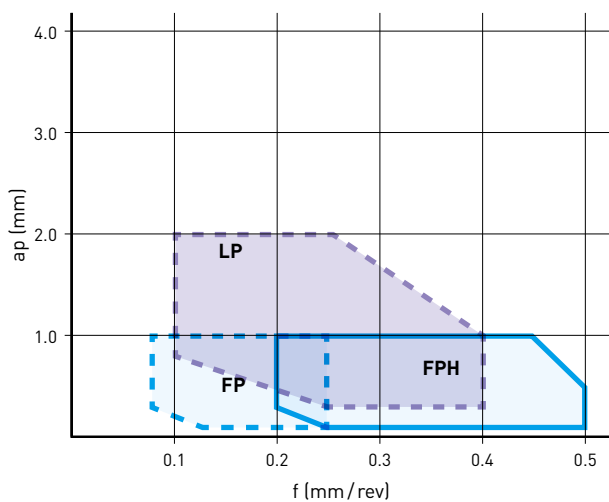
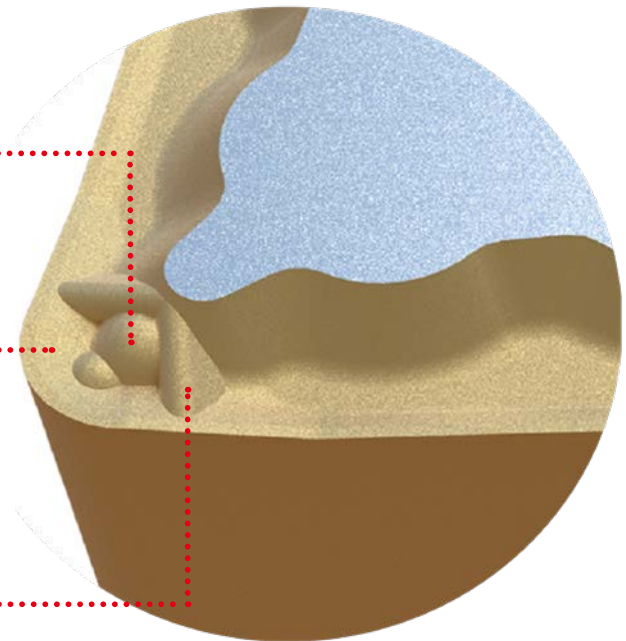

HOW TO USE

1. When using the FPH chipbreaker, keep the depth of cut to 1 mm or less and the feed rate per revolution to 0.2 mm/rev or more.
2. If the depth of cut is 1 mm or more, we recommend using an LP chipbreaker.
3. If the feed rate per revolution is less than 0.2 mm/rev, we recommend an FP chipbreaker.

FPH CHIPBREAKER

CUTTING PERFORMANCE

DIN 1.7225 (42CRM04): COMPARISON OF CHIPS AND FINISHED SURFACE

The FPH chipbreaker has excellent chip breaking properties, therefore a good component surface finish can always be expected.

Material	DIN 1.7225 (42CrMo4)
Insert	CNMG120408- MC6125
Vc (m/min)	200
f (mm/rev)	The fluctuation values are shown in the image.
ap (mm)	0.2
Cutting mode	Wet cutting

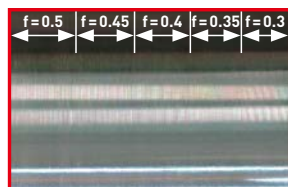

MC6135 + FPH

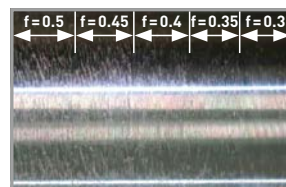

Conventional

CHIP COMPARISON

Material	DIN 1.7225 (42CrMo4)
Insert	DNMG150408-
Vc (m/min)	200
f (mm/rev)	0.3
ap (mm)	0.2
Cutting mode	Dry cutting

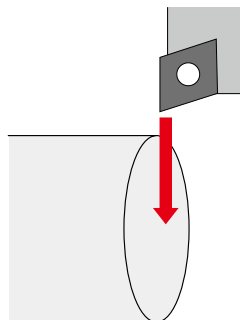







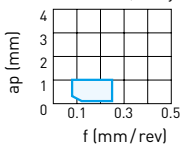
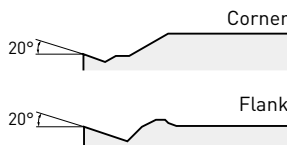

FPH	Conventional finish cutting chipbreaker	Conventional light cutting chipbreaker
Broken into pieces of ideal length.	Excessive division. This is a condition where the finished surface is prone to scratches.	Long chips are being generated. There is a high risk of it wrapping around the workpiece and interrupting the machining process.

MC6100 SERIES

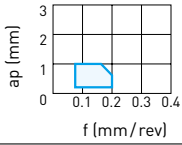
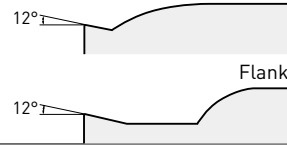
CHIPBREAKER SYSTEM FOR STEEL TURNING

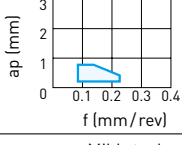
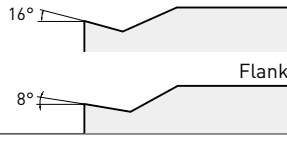

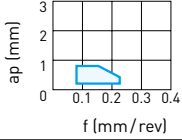
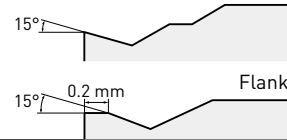





NEGATIVE INSERTS

Tolerance	 Features	Cross section geometry	
M	 FP	FIRST RECOMMENDATION FOR FINISHING CARBON STEEL AND ALLOY STEEL Controls chip clogging during high-feed cutting and prevents chips of soft workpiece materials from running onto their surfaces. Large rake angle suppress chatter vibration and deformation in machining of low rigidity workpiece material.	Carbon steel, Alloy steel  
	 FH	FIRST RECOMMENDATION FOR FINISHING CARBON STEEL AND ALLOY STEEL Stable chip control even at small depths of cut.	Carbon steel, Alloy steel  
	 FS	ALTERNATIVE CHIPBREAKER FOR FINISHING MILD STEEL Stable chip control even at small depths of cut. Sharp edge gives best performance.	Mild steel  
	 FY	FIRST RECOMMENDATION FOR FINISHING MILD STEEL Effectively controls adhesive chips. Suitable for mild steel finishing.	Mild steel  

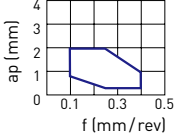
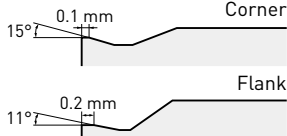
MC6100 SERIES

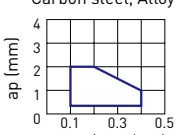
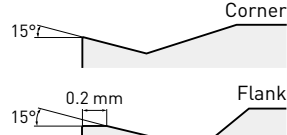
CHIPBREAKER SYSTEM FOR STEEL TURNING

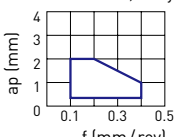
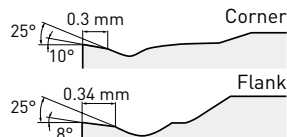
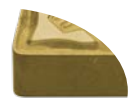
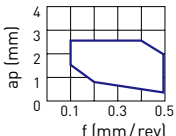
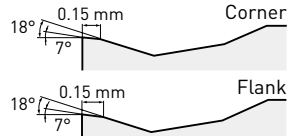

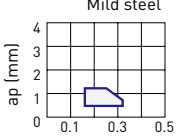
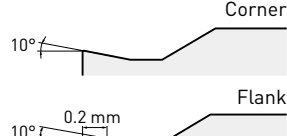







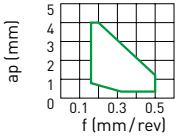
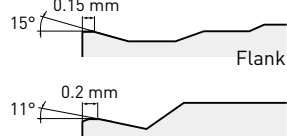

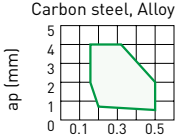
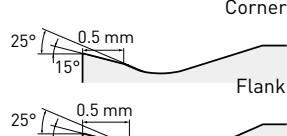

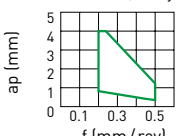
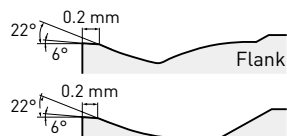

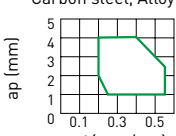
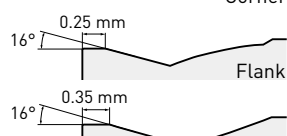
NEGATIVE INSERTS

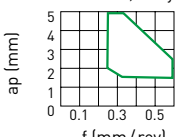
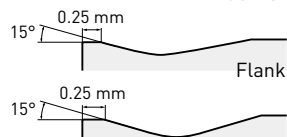
Tolerance	 Features	Cross section geometry	
LIGHT CUTTING			
M	 LP	<p>FIRST RECOMMENDATION FOR LIGHT CUTTING OF CARBON STEEL AND ALLOY STEEL</p> <p>Stable chip control in the light cutting range. The curved edge allows smooth chip discharge.</p>	<p>Carbon steel, Alloy steel</p>  
	 SH	<p>ALTERNATIVE CHIPBREAKER FOR LIGHT CUTTING OF CARBON STEEL AND ALLOY STEEL</p> <p>Can be used at low depth of cuts and high feed rates. The curved edge allows smooth chip discharge. Recommended for workpieces in the 160–250HB range.</p>	<p>Carbon steel, Alloy steel</p>  
	 SA	<p>ALTERNATIVE CHIPBREAKER FOR LIGHT CUTTING OF CARBON STEEL AND ALLOY STEEL</p> <p>Superior chip control at small depths of cuts. Covers copying and back turning with a wavy edge. Recommended for workpieces in the 200–300HB range.</p>	<p>Carbon steel, Alloy steel</p>  
	 SW	<p>WIPER INSERT FOR LIGHT CUTTING OF CARBON STEEL, ALLOY STEEL, STAINLESS STEEL AND CAST IRON</p> <p>In comparison to conventional chipbreakers, the surface finish is maintained even if the feed per revolution is doubled. Wiper design for increased productivity and improved surface finishes.</p>	<p>Carbon steel, Alloy steel</p>  
	 SY	<p>FIRST RECOMMENDATION FOR LIGHT CUTTING OF MILD STEEL</p> <p>Effectively controls adhesive chips. Suitable for mild steel light cutting.</p>	<p>Mild steel</p>  

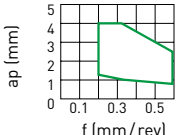
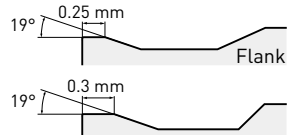
MC6100 SERIES

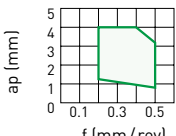
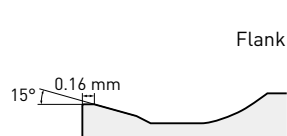
CHIPBREAKER SYSTEM FOR STEEL TURNING

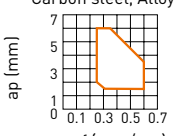
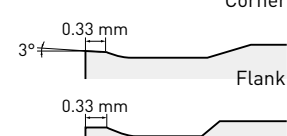

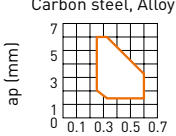
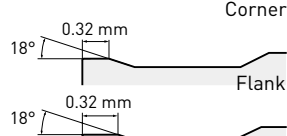





NEGATIVE INSERTS

Tolerance	Features	Cross section geometry		
MEDIUM CUTTING				
M	 MP	<p>FIRST RECOMMENDATION FOR MEDIUM CUTTING OF CARBON STEEL AND ALLOY STEEL Suitable for medium to light cutting. Breaker geometry appropriate for copying and back turning. Cutting edge geometry for an optimum balance of sharpness and fracture resistance.</p>	<p>Carbon steel, Alloy steel</p> 	<p>Corner</p> 
	 MS	<p>ALTERNATIVE CHIPBREAKER FOR MEDIUM CUTTING The sharp edge gives best performance. Flat top chipbreaker shape offers high edge strength. Applicable to grades other than MP9005, MP9015, MP9025, MT9015.</p>	<p>Carbon steel, Alloy steel</p> 	<p>Corner</p> 
	 MA	<p>FIRST RECOMMENDATION FOR MEDIUM CUTTING OF CARBON STEEL AND ALLOY STEEL Ideal for general cutting applications. Positive land provides sharp cutting action.</p>	<p>Carbon steel, Alloy steel</p> 	<p>Corner</p> 
	 MH	<p>ALTERNATIVE CHIPBREAKER FOR MEDIUM CUTTING OF CARBON STEEL AND ALLOY STEEL Flat land offers high edge strength. Good chip control with a suitable chip pocket.</p>	<p>Carbon steel, Alloy steel</p> 	<p>Corner</p> 
	 Standard	<p>ALTERNATIVE CHIPBREAKER FOR MEDIUM CUTTING OF CARBON STEEL AND ALLOY STEEL Flat land offers high edge strength. Flat top breaker shape offers high edge strength.</p>	<p>Carbon steel, Alloy steel</p> 	<p>Corner</p> 
	 MW	<p>WIPER INSERT FOR MEDIUM CUTTING CARBON STEEL, ALLOY STEEL, STAINLESS STEEL AND CAST IRON The wiper allows up to two times higher feed. A wide chip pocket prevents chip jamming.</p>	<p>Carbon steel, Alloy steel</p> 	<p>Corner</p> 
	 R/L-ES	<p>ALTERNATIVE CHIPBREAKER FOR MEDIUM CUTTING OF STAINLESS STEEL Good balance of edge strength and sharpness. Right- or left-hand chipbreaker for unidirectional chip control.</p>	<p>Stainless steel</p> 	<p>Flank</p> 
	ROUGH CUTTING			
M	 RP	<p>FIRST RECOMMENDATION FOR ROUGH CUTTING OF CARBON STEEL AND ALLOY STEEL For interrupted cutting and removing scale. Good balance of cutting edge strength and low cutting resistance because of a suitable rake angle.</p>	<p>Carbon steel, Alloy steel</p> 	<p>Corner</p> 
	 GH	<p>ALTERNATIVE CHIPBREAKER FOR ROUGH CUTTING OF CARBON STEEL, ALLOY STEEL AND CAST IRON For interrupted cutting and removing scale. A combination of a wide land and a large chip pocket allows high feed rates.</p>	<p>Carbon steel, Alloy steel</p> 	<p>Corner</p> 

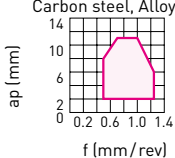
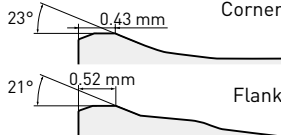
MC6100 SERIES

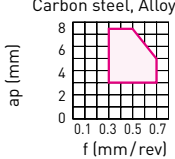
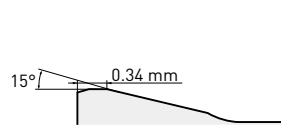
CHIPBREAKER SYSTEM FOR STEEL TURNING

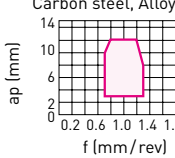
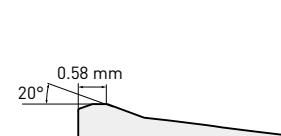

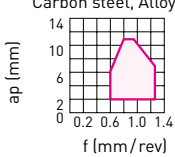
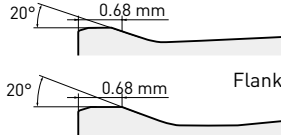







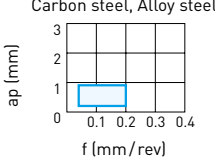
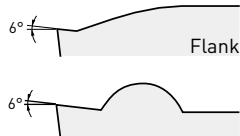

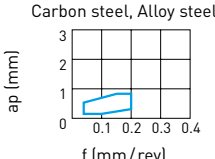
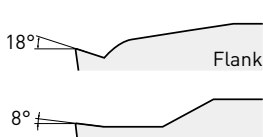

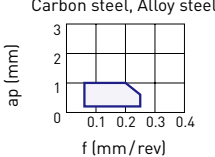
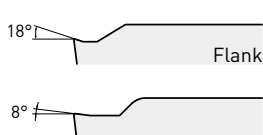
NEGATIVE INSERTS

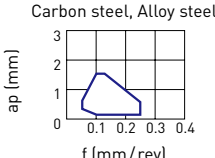
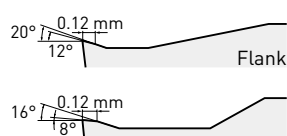
Tolerance	 Features	Cross section geometry	
M	HEAVY CUTTING		
	 HX	<p>FIRST RECOMMENDATION FOR HEAVY CUTTING OF CARBON STEEL AND ALLOY STEEL</p> <p>Covers the medium range of the heavy cutting region. Owing to the straight edge and chamfer, it gives a balance of sharpness and strength. Variable land and a wavy chipbreaker for good chip control.</p>	<p>Carbon steel, Alloy steel</p>  
	 HL	<p>FIRST RECOMMENDATION FOR HEAVY CUTTING ALTERNATIVE CHIPBREAKER FOR HEAVY CUTTING OF CARBON STEEL AND ALLOY STEEL</p> <p>Low resistance due to narrow flat land. Achieves high chip breaking ability.</p>	<p>Carbon steel, Alloy steel</p>  
	 HR	<p>ALTERNATIVE CHIPBREAKER FOR HEAVY CUTTING OF CARBON STEEL AND ALLOY STEEL</p> <p>High cutting edge strength. Excellent chip discharge even with high feed and high depth of cut.</p>	<p>Carbon steel, Alloy steel</p>  
	 HV	<p>ALTERNATIVE CHIPBREAKER FOR HEAVY CUTTING OF CARBON STEEL AND ALLOY STEEL</p> <p>Covers the upper end of the heavy cutting region. Wide land and large chamfer offer high edge strength. A wide chipbreaker prevents chip jamming.</p>	<p>Carbon steel, Alloy steel</p>  

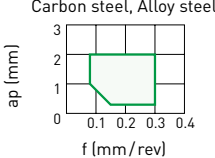
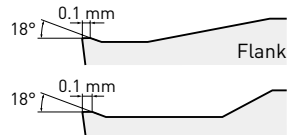
MC6100 SERIES

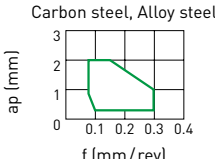
CHIPBREAKER SYSTEM FOR STEEL TURNING

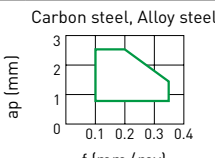
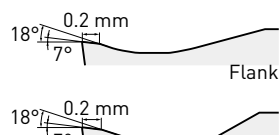

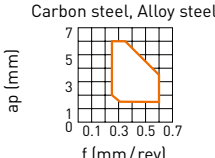
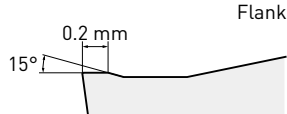
5°, 7° POSITIVE INSERTS

Tolerance	Features	Cross section geometry
FINISH CUTTING		
M	 <p>FP</p> <p>FIRST RECOMMENDATION FOR FINISHING CARBON STEEL, ALLOY STEEL AND MILD STEEL Chipbreaker protrusion at the corner tip controls chips even at small depth of cut. Maintains the edge strength at the corner and prevents sudden fractures.</p>	<p>Carbon steel, Alloy steel</p>  
	 <p>FV</p> <p>ALTERNATIVE CHIPBREAKER FOR FINISHING CARBON STEEL, ALLOY STEEL, MILD STEEL AND STAINLESS STEEL Suitable for low depths of cut and low feed rates. Sharp cutting edge and low resistance design achieves excellent cutting performance.</p>	<p>Carbon steel, Alloy steel</p>  
LIGHT CUTTING		
M	 <p>LP</p> <p>FIRST RECOMMENDATION FOR LIGHT CUTTING OF CARBON STEEL, ALLOY STEEL AND MILD STEEL Sharp cutting edge due to a large rake angle. Prevents welding of the insert and controls white turbidity of the surface finish. Chipbreaker protrusion suitable for depth of cut area achieves a wide range of chip control.</p>	<p>Carbon steel, Alloy steel</p>  
	 <p>SW</p> <p>WIPER INSERT FOR LIGHT CUTTING OF CARBON STEEL, ALLOY STEEL, MILD STEEL AND STAINLESS STEEL In comparison to conventional chipbreakers, the surface finish is maintained even if the feed per revolution is doubled. Positive land improves sharpness.</p>	<p>Carbon steel, Alloy steel</p>  
MEDIUM CUTTING		
M	 <p>MP</p> <p>FIRST RECOMMENDATION FOR MEDIUM CUTTING OF CARBON STEEL, ALLOY STEEL AND MILD STEEL Good balance of wear resistance and fracture resistance because of the flat land cutting edge. A wide chip pocket controls increasing of the cutting resistance and reduces vibration and chip jamming even at large depths of cut.</p>	<p>Carbon steel, Alloy steel</p>  
	 <p>MV</p> <p>ALTERNATIVE CHIPBREAKER FOR MEDIUM CUTTING OF CARBON STEEL, ALLOY STEEL, MILD STEEL AND STAINLESS STEEL A positive insert and the large rake angle achieve sharp cutting edge performance. The double breakers and round shape in the rake face achieve a wide range of chip discharge.</p>	<p>Carbon steel, Alloy steel</p>  
	 <p>MW</p> <p>WIPER INSERT FOR MEDIUM CUTTING OF CARBON STEEL, ALLOY STEEL, MILD STEEL AND STAINLESS STEEL The wiper allows up to two times higher feed. A wide chip pocket prevents chip jamming.</p>	<p>Carbon steel, Alloy steel</p>  
	 <p>Standard</p> <p>ALTERNATIVE CHIPBREAKER FOR MEDIUM CUTTING OF CARBON STEEL, ALLOY STEEL, MILD STEEL, STAINLESS STEEL AND CAST IRON Balance of edge strength and sharpness due to a combination of a flat land and large rake angle.</p>	<p>Carbon steel, Alloy steel</p>  



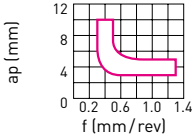
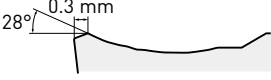

MC6100 SERIES

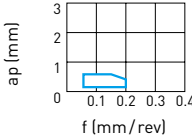
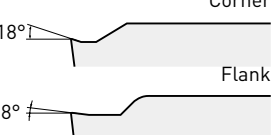
CHIPBREAKER SYSTEM FOR STEEL TURNING

7° POSITIVE INSERTS

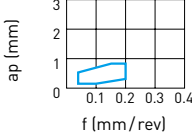
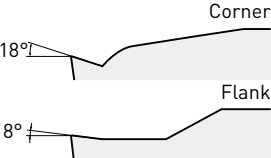
Tolerance	Features	Cross section geometry
HEAVY CUTTING		
M	 <p>RR</p> <p>CHIPBREAKER FOR HEAVY CUTTING OF CARBON STEEL AND ALLOY STEEL A wide groove chipbreaker prevents chips from jamming at large depths of cut. Small dimples improve chip control at small depths of cut.</p>	<p>Carbon steel, Alloy steel</p>  
FINISH CUTTING		
M	 <p>SVX</p> <p>ALTERNATIVE CHIPBREAKER FOR LIGHT CUTTING OF CARBON STEEL AND ALLOY STEEL Chip control is improved by having a chipbreaker geometry suitable for copying.</p>	<p>Carbon steel, Alloy steel</p>  

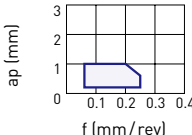
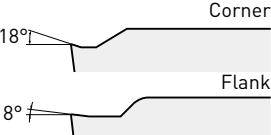

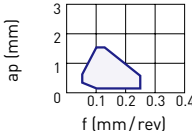
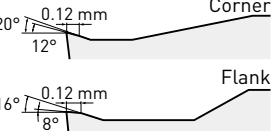





11° POSITIVE INSERTS

Tolerance	Features	Cross section geometry
FINISH CUTTING		
M	 <p>FV</p> <p>FIRST RECOMMENDATION FOR FINISHING CARBON STEEL, ALLOY STEEL, MILD STEEL AND STAINLESS STEEL Suitable for low depths of cut and low feed rates. Sharp cutting edge and low resistance design achieves excellent cutting performance.</p>	<p>Carbon steel, Alloy steel</p>  
LIGHT CUTTING		
M	 <p>LP</p> <p>FIRST RECOMMENDATION FOR LIGHT CUTTING OF CARBON STEEL, ALLOY STEEL AND MILD STEEL Sharp cutting edge due to a large rake angle. Prevents welding of the insert and controls white turbidity of the surface finish. Chipbreaker protrusion suitable for depth of cut area achieves a wide range of chip control.</p>	<p>Carbon steel, Alloy steel</p>  
	 <p>SW</p> <p>WIPER INSERT FOR LIGHT CUTTING OF CARBON STEEL, ALLOY STEEL, MILD STEEL AND STAINLESS STEEL In comparison to conventional chip breakers, the surface finish is maintained even if the feed per revolution is doubled. Positive land improves sharpness.</p>	<p>Carbon steel, Alloy steel</p>  

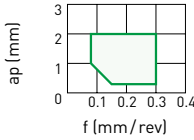
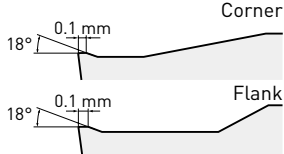
MC6100 SERIES

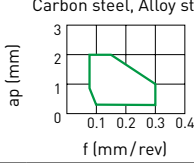
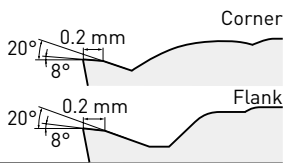
CHIPBREAKER SYSTEM FOR STEEL TURNING

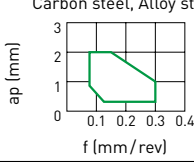
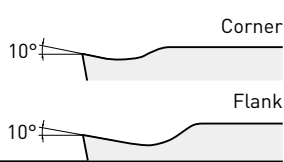
11° POSITIVE INSERTS

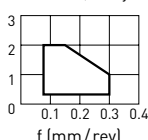
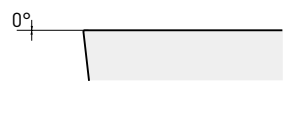
Tolerance	 Features	Cross section geometry
MEDIUM CUTTING		
M	 <p>MP</p> <p>FIRST RECOMMENDATION FOR MEDIUM CUTTING OF CARBON STEEL, ALLOY STEEL AND MILD STEEL Good balance of wear resistance and fracture resistance because of the flat land cutting edge. A wide chip pocket controls increasing of the cutting resistance and reduces vibration and chip jamming even at large depths of cut.</p>	<p>Carbon steel, Alloy steel</p>  
M	 <p>MV</p> <p>FIRST RECOMMENDATION FOR MEDIUM CUTTING OF CARBON STEEL, ALLOY STEEL, MILD STEEL, STAINLESS STEEL AND CAST IRON A positive insert and large rake angle achieves sharp cutting edge performance. Double chipbreaker in the rake face achieve a wide range of chip discharge.</p>	<p>Carbon steel, Alloy steel</p>  
M	 <p>Standard</p> <p>ALTERNATIVE CHIPBREAKER FOR MEDIUM CUTTING OF CARBON STEEL, ALLOY STEEL AND STAINLESS STEEL Standard, general purpose chipbreaker.</p>	<p>Carbon steel, Alloy steel</p>  
FOR CAST IRON		
M	 <p>Flat Top</p> <p>CHIPBREAKER FOR HEAVY CUTTING OF CAST IRON Flat top. Most effective for unstable machining due to its high edge strength.</p>	<p>Carbon steel, Alloy steel</p>  

MC6115

CUTTING PERFORMANCE

MACHINING C45: COMPARISON OF WEAR RESISTANCE DURING CONTINUOUS DRY CUTTING

Material	C45
Insert	CNMG120408-00
Vc (m/min)	300
f (mm/rev)	0.3
ap (mm)	1.5
Cutting mode	Dry cutting



MC6115
10 min

Conventional A
10 min

Conventional B
8 min

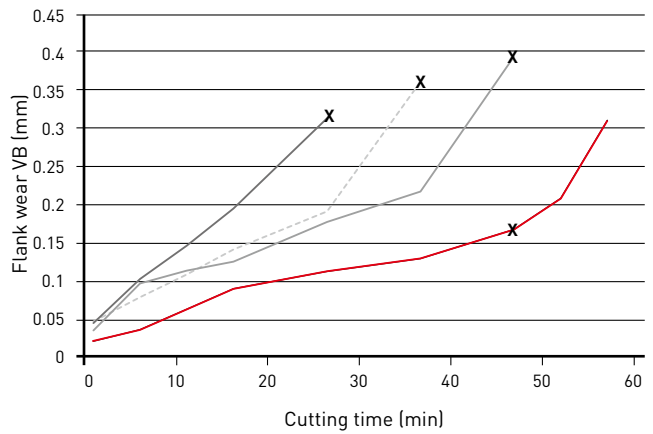

MACHINING DIN 100CR6: COMPARISON OF WEAR RESISTANCE DURING CONTINUOUS WET CUTTING

Material	DIN 100Cr6
Insert	CNMG120408-00
Vc (m/min)	300
f (mm/rev)	0.3
ap (mm)	1.5
Cutting mode	Wet cutting

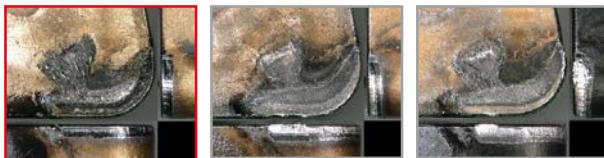

MC6115
12 min

Conventional A
12 min

Conventional B
12 min

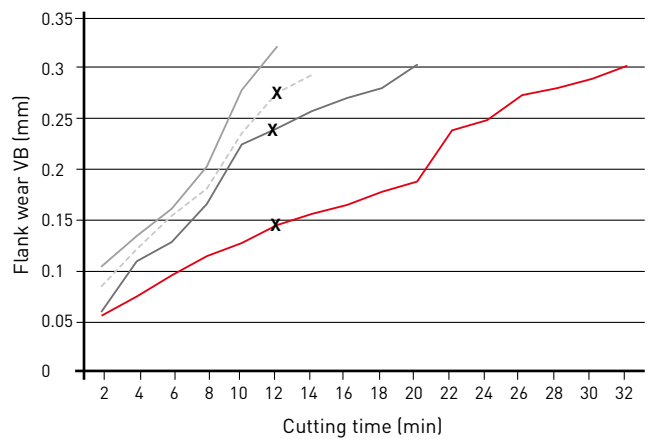

MACHINING DIN41CRM04: COMPARISON OF WEAR RESISTANCE DURING CONTINUOUS WET CUTTING

Material	DIN 41CrMo4
Insert	CNMG120408-00
Vc (m/min)	350
f (mm/rev)	0.3
ap (mm)	1.5
Cutting mode	Wet cutting



MC6115
10 min

Conventional A
10 min

Conventional B
8 min

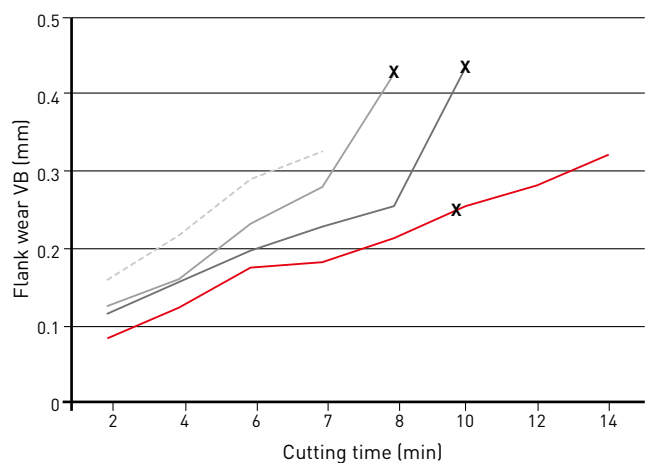

MC6125

CUTTING PERFORMANCE

COMPARISON OF TOUGHNESS DURING INTERRUPTED CUTTING

Material	DIN 42CrMo4
Insert	CNMG120408- 
Vc (m/min)	200
f (mm/rev)	0.25
ap (mm)	1.5
Cutting mode	Wet cutting

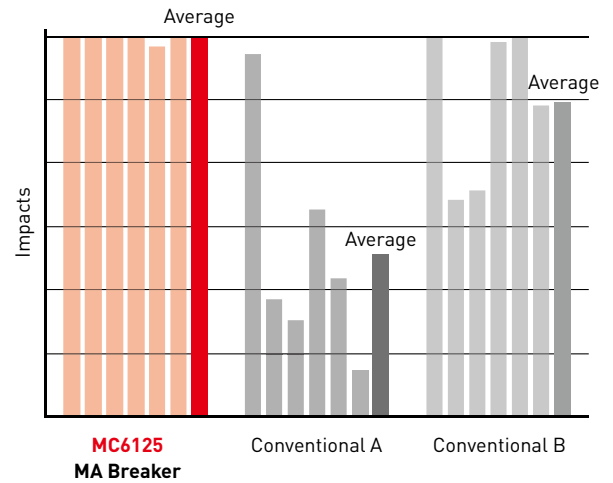

MACHINING DIN 20MNCr5: COMPARISON OF WEAR RESISTANCE DURING CONTINUOUS WET CUTTING

Material	DIN 20MNCr5
Insert	CNMG120408- 
Vc (m/min)	300
f (mm/rev)	0.3
ap (mm)	1.5
Cutting mode	Wet cutting



MC6125
46 min

Conventional A
46 min

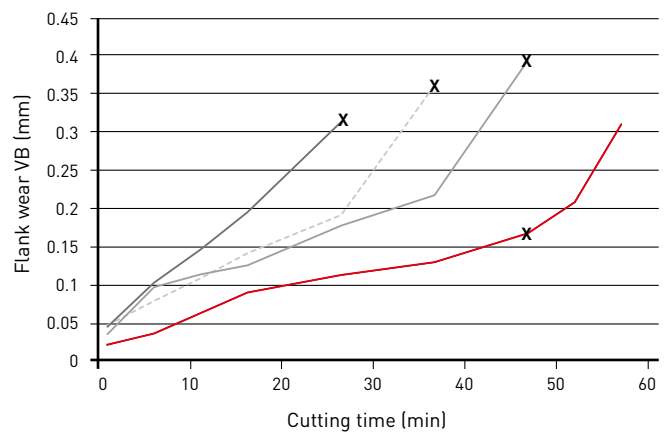





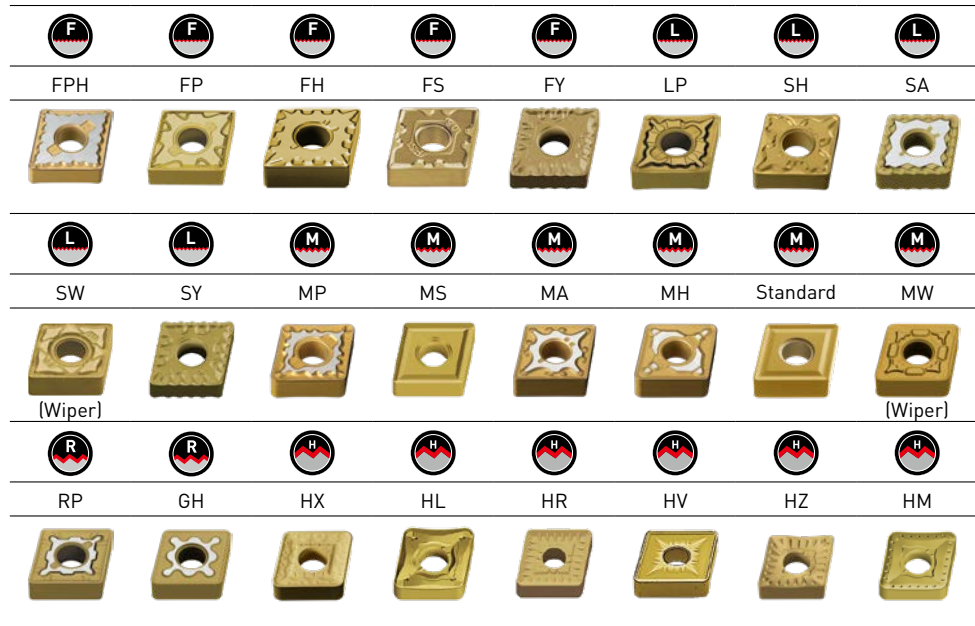
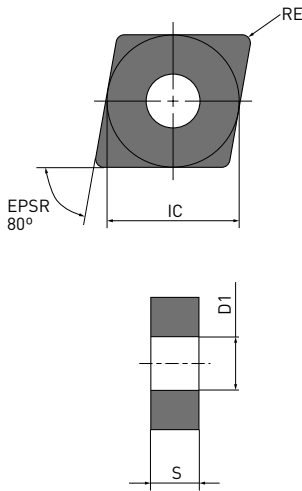

CNMG, CNMM

NEGATIVE INSERTS (WITH HOLE)

M Class

CNMG, CNMM



Order number	  		MC6115	MC6125	MC6135	IC	S	RE	D1
	 								
CNMG120404-FPH	F	●	●	●	12.7	4.76	0.4	5.16	
CNMG120408-FPH	F	●	●	●	12.7	4.76	0.8	5.16	
CNMG120412-FPH	F	●	●	●	12.7	4.76	1.2	5.16	
CNMG120402-FP	F	★	★	★	12.7	4.76	0.2	5.16	
CNMG120404-FP	F	●	★	★	12.7	4.76	0.4	5.16	
CNMG120408-FP	F	●	★	★	12.7	4.76	0.8	5.16	
CNMG120412-FP	F	★	★	★	12.7	4.76	1.2	5.16	
CNMG120402-FH	F	★	★	★	12.7	4.76	0.2	5.16	
CNMG120404-FH	F	★	★	★	12.7	4.76	0.4	5.16	
CNMG120408-FH	F	★	★		12.7	4.76	0.8	5.16	
CNMG120404-FS	F		★	★	12.7	4.76	0.4	5.16	
CNMG120404-FY	F	●	★	★	12.7	4.76	0.4	5.16	
CNMG120408-FY	F	●	●	★	12.7	4.76	0.8	5.16	
CNMG120404-LP	L	●	●	★	12.7	4.76	0.4	5.16	
CNMG120408-LP	L	●	●	★	12.7	4.76	0.8	5.16	
CNMG120412-LP	L	●	●	★	12.7	4.76	1.2	5.16	
CNMG09T304-SH	L	★	●		9.525	3.97	0.4	3.81	
CNMG09T308-SH	L	★	●		9.525	3.97	0.8	3.81	
CNMG120404-SH	L	★	★	★	12.7	4.76	0.4	5.16	
CNMG120408-SH	L	★	★	★	12.7	4.76	0.8	5.16	
CNMG120412-SH	L	★	★	★	12.7	4.76	1.2	5.16	
CNMG120404-SA	L	★	★	★	12.7	4.76	0.4	5.16	
CNMG120408-SA	L	●	★	★	12.7	4.76	0.8	5.16	
CNMG120412-SA	L	★	★	★	12.7	4.76	1.2	5.16	
CNMG120404-SW	L	●	★		12.7	4.76	0.4	5.16	
CNMG120408-SW	L	●	★		12.7	4.76	0.8	5.16	
CNMG120412-SW	L	●	★		12.7	4.76	1.2	5.16	

(10 inserts in one case)

● / ★ = Expansion

● : Inventory maintained. ★ : Inventory maintained in Japan.

CNMG, CNMM – NEGATIVE INSERTS (WITH HOLE)

Order number		MC6115	MC6125	MC6135	IC	S	RE	D1
CNMG120404-SY	L	★	★	★	12.7	4.76	0.4	5.16
CNMG120408-SY	L	●	●	★	12.7	4.76	0.8	5.16
CNMG120404-MP	M	●	●	●	12.7	4.76	0.4	5.16
CNMG120408-MP	M	●	●	●	12.7	4.76	0.8	5.16
CNMG120412-MP	M	●	●	●	12.7	4.76	1.2	5.16
CNMG120416-MP	M	●	●	★	12.7	4.76	1.6	5.16
CNMG160608-MP	M	★	●	★	15.875	6.35	0.8	6.35
CNMG160612-MP	M	★	●	★	15.875	6.35	1.2	6.35
CNMG160616-MP	M	★	●	★	15.875	6.35	1.6	6.35
CNMG090308-MS	M	★	★		9.525	3.18	0.8	3.81
CNMG09T308-MS	M	★	●		9.525	3.97	0.8	3.81
CNMG120404-MS	M	★	★	★	12.7	4.76	0.4	5.16
CNMG120408-MS	M	●	★	★	12.7	4.76	0.8	5.16
CNMG120412-MS	M	★	★		12.7	4.76	1.2	5.16
CNMG120404-MA	M	●	●	★	12.7	4.76	0.4	5.16
CNMG120408-MA	M	●	●	●	12.7	4.76	0.8	5.16
CNMG120412-MA	M	●	●	●	12.7	4.76	1.2	5.16
CNMG120416-MA	M	★	★	★	12.7	4.76	1.6	5.16
CNMG160608-MA	M	●	●	★	15.875	6.35	0.8	6.35
CNMG160612-MA	M	●	●	★	15.875	6.35	1.2	6.35
CNMG160616-MA	M	●	●	★	15.875	6.35	1.6	6.35
CNMG190612-MA	M	●	●	★	19.05	6.35	1.2	7.93
CNMG190616-MA	M	●	●	★	19.05	6.35	1.6	7.93
CNMG120404-MH	M	★	●	★	12.7	4.76	0.4	5.16
CNMG120408-MH	M	●	●	★	12.7	4.76	0.8	5.16
CNMG120412-MH	M	●	●	★	12.7	4.76	1.2	5.16
CNMG120416-MH	M	★	●	★	12.7	4.76	1.6	5.16
CNMG160608-MH	M	★	★		15.875	6.35	0.8	6.35
CNMG160612-MH	M	●	●	★	15.875	6.35	1.2	6.35
CNMG160616-MH	M	★	★		15.875	6.35	1.6	6.35
CNMG190612-MH	M	●	●	★	19.05	6.35	1.2	7.93
CNMG190616-MH	M	★	●	★	19.05	6.35	1.6	7.93
CNMG090308	M	★	★		9.525	3.18	0.8	3.81
CNMG09T304	M	★	★	★	9.525	3.97	0.4	3.81
CNMG09T308	M	★	★	★	9.525	3.97	0.8	3.81
CNMG120404	M	●	●	★	12.7	4.76	0.4	5.16
CNMG120408	M	●	●	★	12.7	4.76	0.8	5.16
CNMG120412	M	●	●	●	12.7	4.76	1.2	5.16
CNMG120416	M	●	●	★	12.7	4.76	1.6	5.16
CNMG160608	M	●	●	★	15.875	6.35	0.8	6.35
CNMG160612	M	●	●	★	15.875	6.35	1.2	6.35
CNMG160616	M	●	●	★	15.875	6.35	1.6	6.35
CNMG190608	M	●	●	★	19.05	6.35	0.8	7.93
CNMG190612	M	●	●	★	19.05	6.35	1.2	7.93
CNMG190616	M	●	●	★	19.05	6.35	1.6	7.93
CNMG120408-MW	M	●	●	★	12.7	4.76	0.8	5.16
CNMG120412-MW	M	●	●	★	12.7	4.76	1.2	5.16

2/3

(10 inserts in one case)



CNMG, CNMM – NEGATIVE INSERTS (WITH HOLE)

Order number			MC6115	MC6125	MC6135	IC	S	RE	D1
CNMG120408-RP	R	●	●	●	12.7	4.76	0.8	5.16	
CNMG120412-RP	R	●	●	●	12.7	4.76	1.2	5.16	
CNMG120416-RP	R	●	●	★	12.7	4.76	1.6	5.16	
CNMG160612-RP	R	●	●	●	15.875	6.35	1.2	6.35	
CNMG160616-RP	R	●	●	●	15.875	6.35	1.6	6.35	
CNMG190612-RP	R	●	●	●	19.05	6.35	1.2	7.93	
CNMG190616-RP	R	●	●	●	19.05	6.35	1.6	7.93	
CNMG120408-GH	R	★	●	★	12.7	4.76	0.8	5.16	
CNMG120412-GH	R	★	●	★	12.7	4.76	1.2	5.16	
CNMG120416-GH	R	★	★		12.7	4.76	1.6	5.16	
CNMG160612-GH	R	★	●	★	15.875	6.35	1.2	6.35	
CNMG160616-GH	R	★	●		15.875	6.35	1.6	6.35	
CNMG190612-GH	R	★	●	★	19.05	6.35	1.2	7.93	
CNMG190616-GH	R	★	●	★	19.05	6.35	1.6	7.93	
CNMM120408-HX	H		★	★	12.7	4.76	0.8	5.16	
CNMM120412-HX	H		★	★	12.7	4.76	1.2	5.16	
CNMM160612-HX	H		★	★	15.875	6.35	1.2	6.35	
CNMM160616-HX	H		★	★	15.875	6.35	1.6	6.35	
CNMM190612-HX	H	★	●	★	19.05	6.35	1.2	7.93	
CNMM190616-HX	H	★	●	★	19.05	6.35	1.6	7.93	
CNMM190624-HX	H	★	●	★	19.05	6.35	2.4	7.93	
CNMM250924-HX	H	●	★	●	25.4	9.52	2.4	9.12	
CNMM120408-HL	H		●	●	12.7	4.76	0.8	5.16	
CNMM120412-HL	H		●	★	12.7	4.76	1.2	5.16	
CNMM120416-HL	H			●	12.7	4.76	1.6	5.16	
CNMM160612-HL	H		●	●	15.875	6.35	1.2	6.35	
CNMM160616-HL	H		★	★	15.875	6.35	1.6	6.35	
CNMM190612-HL	H		●	●	19.05	6.35	1.2	7.93	
CNMM190616-HL	H		●	★	19.05	6.35	1.6	7.93	
CNMM190624-HL	H		★	★	19.05	6.35	2.4	7.93	
CNMM250924-HR	H	●	●	●	25.4	9.52	2.4	9.12	
CNMM190616-HV	H	★	●	★	19.05	6.35	1.6	7.93	
CNMM190624-HV	H	★	★	★	19.05	6.35	2.4	7.93	
CNMM250924-HV	H	★	●	●	25.4	9.52	2.4	9.12	
CNMM120408-HZ	H	●	●	★	12.7	4.76	0.8	5.16	
CNMM120412-HZ	H	●	●	★	12.7	4.76	1.2	5.16	
CNMM120416-HZ	H			★	12.7	4.76	1.6	5.16	
CNMM160612-HZ	H	●	●	★	15.875	6.35	1.2	6.35	
CNMM160616-HZ	H	★	★	★	15.875	6.35	1.6	6.35	
CNMM190612-HZ	H	★	●	★	19.05	6.35	1.2	7.93	
CNMM190616-HZ	H	★	●	★	19.05	6.35	1.6	7.93	
CNMM160612-HM	H		●	★	15.875	6.35	1.2	6.35	
CNMM160616-HM	H		★	★	15.875	6.35	1.6	6.35	
CNMM190612-HM	H		●	●	19.05	6.35	1.2	7.93	
CNMM190616-HM	H		●	★	19.05	6.35	1.6	7.93	
CNMM190624-HM	H		★	★	19.05	6.35	2.4	7.93	
CNMM250924-HM	H	★	★	●	25.4	9.52	2.4	9.12	

3/3

(10 inserts in one case)



● : Inventory maintained. ★ : Inventory maintained in Japan.

DNMG, DNMX, DNMM, RNMG

NEGATIVE INSERTS (WITH HOLE)

M Class

DNMG, DNMX, DNMM

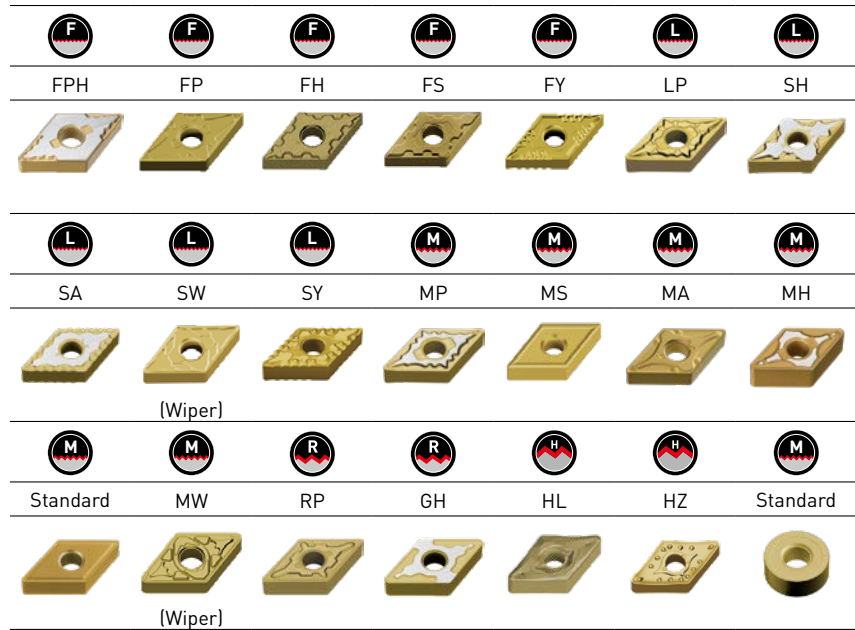
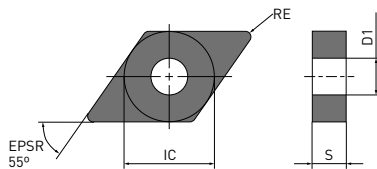

RNMG

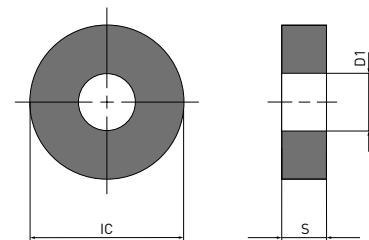

Order number		MC6115	MC6125	MC6135	IC	S	RE	D1
DNMG150404-FPH	F	★	★	★	12.7	4.76	0.4	5.16
DNMG150408-FPH	F	★	★	★	12.7	4.76	0.8	5.16
DNMG150412-FPH	F	★	★	★	12.7	4.76	1.2	5.16
DNMG150604-FPH	F	●	●	●	12.7	6.35	0.4	5.16
DNMG150608-FPH	F	●	●	●	12.7	6.35	0.8	5.16
DNMG150612-FPH	F	●	●	●	12.7	6.35	1.2	5.16
DNMG150402-FP	F	★	★	★	12.7	4.76	0.2	5.16
DNMG150404-FP	F	★	★	★	12.7	4.76	0.4	5.16
DNMG150408-FP	F	★	★	★	12.7	4.76	0.8	5.16
DNMG150412-FP	F	★	★	★	12.7	4.76	1.2	5.16
DNMG150602-FP	F	★	★	★	12.7	6.35	0.2	5.16
DNMG150604-FP	F	●	★	★	12.7	6.35	0.4	5.16
DNMG150608-FP	F	●	★	★	12.7	6.35	0.8	5.16
DNMG150612-FP	F	★	★	★	12.7	6.35	1.2	5.16
DNMG150402-FH	F	★	★	★	12.7	4.76	0.2	5.16
DNMG150404-FH	F	★	★		12.7	4.76	0.4	5.16
DNMG150408-FH	F	★	★		12.7	4.76	0.8	5.16
DNMG150602-FH	F	★	★	★	12.7	6.35	0.2	5.16
DNMG150604-FH	F	●	★	★	12.7	6.35	0.4	5.16
DNMG150608-FH	F	★	★	★	12.7	6.35	0.8	5.16
DNMG150408-FS	F		★	★	12.7	4.76	0.8	5.16
DNMG150404-FY	F	★	★	★	12.7	4.76	0.4	5.16
DNMG150408-FY	F	★	★	★	12.7	4.76	0.8	5.16
DNMG150608-FY	F	●	●	★	12.7	6.35	0.8	5.16

(10 inserts in one case)



● / ★ = Expansion

● : Inventory maintained. ★ : Inventory maintained in Japan.

DNMG, DNMX, DNMM, RNMG – NEGATIVE INSERTS (WITH HOLE)

Order number		MC6115	MC6125	MC6135	IC	S	RE	D1
DNMG110404-LP	L	●	●	●	9.525	4.76	0.4	3.81
DNMG110408-LP	L	●	●	●	9.525	4.76	0.8	3.81
DNMG150404-LP	L	●	●	★	12.7	4.76	0.4	5.16
DNMG150408-LP	L	●	●	★	12.7	4.76	0.8	5.16
DNMG150412-LP	L	●	●	★	12.7	4.76	1.2	5.16
DNMG150604-LP	L	●	●	★	12.7	6.35	0.4	5.16
DNMG150608-LP	L	●	●	★	12.7	6.35	0.8	5.16
DNMG150612-LP	L	●	●	★	12.7	6.35	1.2	5.16
DNMG110404-SH	L	●	★		9.525	4.76	0.4	3.81
DNMG110408-SH	L	●	●		9.525	4.76	0.8	3.81
DNMG150404-SH	L	★	★	★	12.7	4.76	0.4	5.16
DNMG150408-SH	L	★	★	★	12.7	4.76	0.8	5.16
DNMG150412-SH	L	★	★	★	12.7	4.76	1.2	5.16
DNMG150604-SH	L	★	★		12.7	6.35	0.4	5.16
DNMG150608-SH	L	★	★		12.7	6.35	0.8	5.16
DNMG150612-SH	L	★	★		12.7	6.35	1.2	5.16
DNMG150404-SA	L	★	★	★	12.7	4.76	0.4	5.16
DNMG150408-SA	L	★	★	★	12.7	4.76	0.8	5.16
DNMG150412-SA	L	★	★	★	12.7	4.76	1.2	5.16
DNMG150604-SA	L	★	●	★	12.7	6.35	0.4	5.16
DNMG150608-SA	L	★	●	★	12.7	6.35	0.8	5.16
DNMG150612-SA	L	●	●	★	12.7	6.35	1.2	5.16
DNMX110404-SW	L	●	●		9.525	4.76	0.4	3.81
DNMX110408-SW	L	●	●		9.525	4.76	0.8	3.81
DNMX150404-SW	L	●	●		12.7	4.76	0.4	5.16
DNMX150408-SW	L	●	●		12.7	4.76	0.8	5.16
DNMX150412-SW	L	●	★		12.7	4.76	1.2	5.16
DNMX150604-SW	L	●	●		12.7	6.35	0.4	5.16
DNMX150608-SW	L	●	●		12.7	6.35	0.8	5.16
DNMX150612-SW	L	●	●		12.7	6.35	1.2	5.16
DNMG150404-SY	L	●	●	★	12.7	4.76	0.4	5.16
DNMG150408-SY	L	●	●	★	12.7	4.76	0.8	5.16
DNMG150608-SY	L	●	●	★	12.7	6.35	0.8	5.16
DNMG150404-MP	M	●	●	★	12.7	4.76	0.4	5.16
DNMG150408-MP	M	●	●	★	12.7	4.76	0.8	5.16
DNMG150412-MP	M	●	●	★	12.7	4.76	1.2	5.16
DNMG150416-MP	M	★	●	★	12.7	4.76	1.6	5.16
DNMG150604-MP	M	●	●	●	12.7	6.35	0.4	5.16
DNMG150608-MP	M	●	●	●	12.7	6.35	0.8	5.16
DNMG150612-MP	M	●	●	★	12.7	6.35	1.2	5.16
DNMG150616-MP	M	●	●	●	12.7	6.35	1.6	5.16
DNMG110408-MS	M	★	●		9.525	4.76	0.8	3.81
DNMG150404-MS	M	★	★	★	12.7	4.76	0.4	5.16
DNMG150408-MS	M	★	★		12.7	4.76	0.8	5.16
DNMG150412-MS	M	★	★		12.7	4.76	1.2	5.16
DNMG150604-MS	M	●	●		12.7	6.35	0.4	5.16
DNMG150608-MS	M	★	★		12.7	6.35	0.8	5.16
DNMG150612-MS	M	★	★		12.7	6.35	1.2	5.16

(10 inserts in one case)



DNMG, DNMX, DNMM, RNMG – NEGATIVE INSERTS (WITH HOLE)

Order number		MC6115	MC6125	MC6135	IC	S	RE	D1
DNMG110404-MA	M	●	●	★	9.525	4.76	0.4	3.81
DNMG110408-MA	M	●	●	★	9.525	4.76	0.8	3.81
DNMG110412-MA	M	●	★	★	9.525	4.76	1.2	3.81
DNMG150404-MA	M	●	●	★	12.7	4.76	0.4	5.16
DNMG150408-MA	M	●	●	●	12.7	4.76	0.8	5.16
DNMG150412-MA	M	●	●	★	12.7	4.76	1.2	5.16
DNMG150604-MA	M	●	●	★	12.7	6.35	0.4	5.16
DNMG150608-MA	M	●	●	●	12.7	6.35	0.8	5.16
DNMG150612-MA	M	●	●	★	12.7	6.35	1.2	5.16
DNMG150616-MA	M	●	●		12.7	6.35	1.6	5.16
DNMG150404-MH	M	★	★	★	12.7	4.76	0.4	5.16
DNMG150408-MH	M	●	●	★	12.7	4.76	0.8	5.16
DNMG150412-MH	M	●	●	★	12.7	4.76	1.2	5.16
DNMG150604-MH	M	★	★		12.7	6.35	0.4	5.16
DNMG150608-MH	M	●	●	★	12.7	6.35	0.8	5.16
DNMG150612-MH	M	●	●	★	12.7	6.35	1.2	5.16
DNMG110408	M	★	●		9.525	4.76	0.8	3.81
DNMG150404	M	●	●	★	12.7	4.76	0.4	5.16
DNMG150408	M	●	●	★	12.7	4.76	0.8	5.16
DNMG150412	M	●	●	★	12.7	4.76	1.2	5.16
DNMG150416	M	★	★	★	12.7	4.76	1.6	5.16
DNMG150604	M	●	●	★	12.7	6.35	0.4	5.16
DNMG150608	M	●	●	★	12.7	6.35	0.8	5.16
DNMG150612	M	●	●	★	12.7	6.35	1.2	5.16
DNMG150616	M	●	★	★	12.7	6.35	1.6	5.16
DNMX150408-MW	M	●	★		12.7	4.76	0.8	5.16
DNMX150412-MW	M	●	★		12.7	4.76	1.2	5.16
DNMX150608-MW	M	●	●		12.7	6.35	0.8	5.16
DNMX150612-MW	M	●	●		12.7	6.35	1.2	5.16
DNMG150408-RP	R	●	●	★	12.7	4.76	0.8	5.16
DNMG150412-RP	R	●	●	★	12.7	4.76	1.2	5.16
DNMG150416-RP	R	★	★	★	12.7	4.76	1.6	5.16
DNMG150608-RP	R	●	●	●	12.7	6.35	0.8	5.16
DNMG150612-RP	R	●	●	●	12.7	6.35	1.2	5.16
DNMG150616-RP	R	●	●	●	12.7	6.35	1.6	5.16
DNMG150408-GH	R	★	●	★	12.7	4.76	0.8	5.16
DNMG150412-GH	R	★	★	★	12.7	4.76	1.2	5.16
DNMG150608-GH	R	★	●	★	12.7	6.35	0.8	5.16
DNMG150612-GH	R	★	●	★	12.7	6.35	1.2	5.16
DNMM150408-HL	H		★	★	12.7	4.76	0.8	5.16
DNMM150412-HL	H		★	★	12.7	4.76	1.2	5.16
DNMM150608-HL	H		●	●	12.7	6.35	0.8	5.16
DNMM150612-HL	H		●	★	12.7	6.35	1.2	5.16
DNMM150408-HZ	H	★	★	★	12.7	4.76	0.8	5.16
DNMM150412-HZ	H	★	★	★	12.7	4.76	1.2	5.16
DNMM150608-HZ	H	★	●	★	12.7	6.35	0.8	5.16
DNMM150612-HZ	H	★	★	★	12.7	6.35	1.2	5.16
RNMG120400	M	★	●	★	12.0	4.76	—	5.16



SNMG, SNMM

NEGATIVE INSERTS (WITH HOLE)

M Class

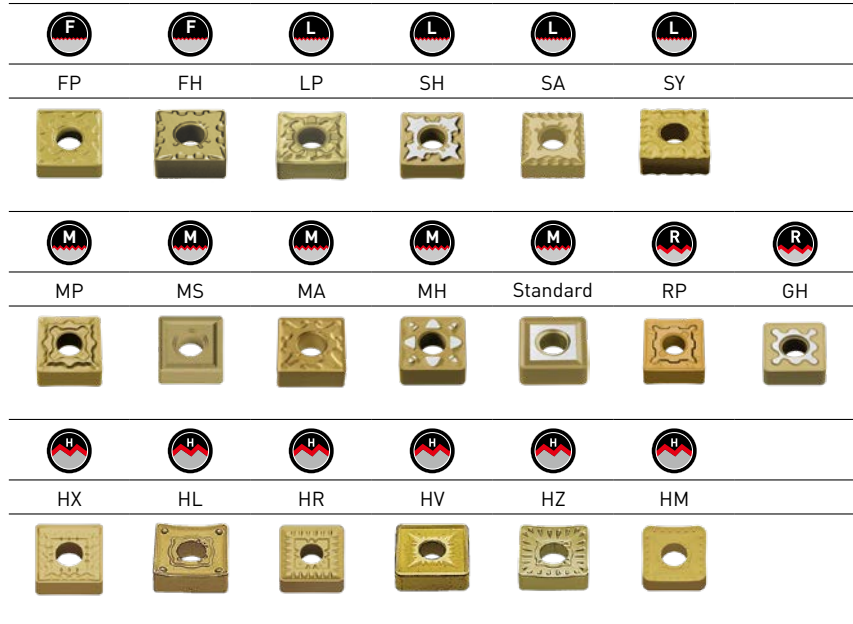
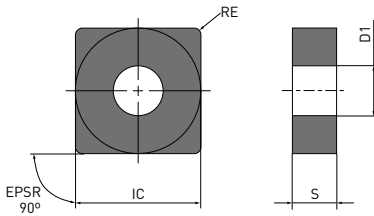
SNMG, SNMM



Order number			MC6115	MC6125	MC6135	IC	S	RE	D1
									
SNMG120404-FP	F		★	★	★	12.7	4.76	0.4	5.16
SNMG120408-FP	F		★	★	★	12.7	4.76	0.8	5.16
SNMG120412-FP	F		★	★	★	12.7	4.76	1.2	5.16
SNMG120404-FH	F		★	★		12.7	4.76	0.4	5.16
SNMG120408-FH	F		★	★		12.7	4.76	0.8	5.16
SNMG120404-LP	L		●	●	★	12.7	4.76	0.4	5.16
SNMG120408-LP	L		●	●	●	12.7	4.76	0.8	5.16
SNMG120412-LP	L		●	●	★	12.7	4.76	1.2	5.16
SNMG120404-SH	L		★	★		12.7	4.76	0.4	5.16
SNMG120408-SH	L		★	●	★	12.7	4.76	0.8	5.16
SNMG120412-SH	L		★	★	★	12.7	4.76	1.2	5.16
SNMG120404-SA	L		★	★		12.7	4.76	0.4	5.16
SNMG120408-SA	L		★	●	★	12.7	4.76	0.8	5.16
SNMG120412-SA	L		●	●	★	12.7	4.76	1.2	5.16
SNMG120408-SY	L		●	★	★	12.7	4.76	0.8	5.16

1/3

(10 inserts in one case)



SNMG, SNMM – NEGATIVE INSERTS (WITH HOLE)

Order number		MC6115	MC6125	MC6135	IC	S	RE	D1
SNMG120404-MP	M	●	●	★	12.7	4.76	0.4	5.16
SNMG120408-MP	M	●	●	★	12.7	4.76	0.8	5.16
SNMG120412-MP	M	●	●	★	12.7	4.76	1.2	5.16
SNMG120404-MS	M	★	★		12.7	4.76	0.4	5.16
SNMG120408-MS	M	★	★	★	12.7	4.76	0.8	5.16
SNMG120412-MS	M	★	★		12.7	4.76	1.2	5.16
SNMG120404-MA	M	●	●	★	12.7	4.76	0.4	5.16
SNMG120408-MA	M	●	●	●	12.7	4.76	0.8	5.16
SNMG120412-MA	M	●	●	★	12.7	4.76	1.2	5.16
SNMG150608-MA	M	★	●	★	15.875	6.35	0.8	6.35
SNMG150612-MA	M	●	●	★	15.875	6.35	1.2	6.35
SNMG150616-MA	M	★	★	★	15.875	6.35	1.6	6.35
SNMG190612-MA	M	●	●	★	19.05	6.35	1.2	7.93
SNMG190616-MA	M	●	●	★	19.05	6.35	1.6	7.93
SNMG120408-MH	M	●	●	★	12.7	4.76	0.8	5.16
SNMG120412-MH	M	●	●	★	12.7	4.76	1.2	5.16
SNMG190612-MH	M	★	●	★	19.05	6.35	1.2	7.93
SNMG190616-MH	M	★	●	★	19.05	6.35	1.6	7.93
SNMG090304	M	★	●	★	9.525	3.18	0.4	3.81
SNMG090308	M	●	●	★	9.525	3.18	0.8	3.81
SNMG120404	M	●	●	★	12.7	4.76	0.4	5.16
SNMG120408	M	●	●	●	12.7	4.76	0.8	5.16
SNMG120412	M	●	●	★	12.7	4.76	1.2	5.16
SNMG120416	M	★	●	★	12.7	4.76	1.6	5.16
SNMG120420	M	★	●	★	12.7	4.76	2.0	5.16
SNMG150612	M	●	●	★	15.875	6.35	1.2	6.35
SNMG150616	M	★	★	★	15.875	6.35	1.6	6.35
SNMG190612	M	●	●	★	19.05	6.35	1.2	7.93
SNMG190616	M	●	●	★	19.05	6.35	1.6	7.93

2/3

(10 inserts in one case)



SNMG, SNMM – NEGATIVE INSERTS (WITH HOLE)

Order number			MC6115	MC6125	MC6135	IC	S	RE	D1
SNMG120408-RP	R	●	●	★	12.7	4.76	0.8	5.16	
SNMG120412-RP	R	●	●	●	12.7	4.76	1.2	5.16	
SNMG120416-RP	R	●	●	★	12.7	4.76	1.6	5.16	
SNMG150612-RP	R	●	●	●	15.875	6.35	1.2	6.35	
SNMG150616-RP	R	●	●	★	15.875	6.35	1.6	6.35	
SNMG190612-RP	R	●	●	●	19.05	6.35	1.2	7.93	
SNMG190616-RP	R	●	●	★	19.05	6.35	1.6	7.93	
SNMG120408-GH	R	★	●	★	12.7	4.76	0.8	5.16	
SNMG120412-GH	R	★	●	★	12.7	4.76	1.2	5.16	
SNMG120416-GH	R	★	★		12.7	4.76	1.6	5.16	
SNMG150612-GH	R	★	●		15.875	6.35	1.2	6.35	
SNMG150616-GH	R	●	●		15.875	6.35	1.6	6.35	
SNMG190612-GH	R	★	●		19.05	6.35	1.2	7.93	
SNMG190616-GH	R	★	●		19.05	6.35	1.6	7.93	
SNMM120408-HX	H		★	★	12.7	4.76	0.8	5.16	
SNMM120412-HX	H		★	★	12.7	4.76	1.2	5.16	
SNMM150612-HX	H		★	★	15.875	6.35	1.2	6.35	
SNMM190612-HX	H	★	●	★	19.05	6.35	1.2	7.93	
SNMM190616-HX	H	★	●	★	19.05	6.35	1.6	7.93	
SNMM190624-HX	H	●	★	★	19.05	6.35	2.4	7.93	
SNMM250724-HX	H	★	★	●	25.4	7.94	2.4	9.12	
SNMM250924-HX	H	★	★	●	25.4	9.52	2.4	9.12	
SNMM120408-HL	H		●	★	12.7	4.76	0.8	5.16	
SNMM120412-HL	H		●	★	12.7	4.76	1.2	5.16	
SNMM150612-HL	H		●	●	15.875	6.35	1.2	6.35	
SNMM190612-HL	H		●	★	19.05	6.35	1.2	7.93	
SNMM190616-HL	H		●	★	19.05	6.35	1.6	7.93	
SNMM190624-HL	H		★	★	19.05	6.35	2.4	7.93	
SNMM250724-HR	H	●	★	●	25.4	7.94	2.4	9.12	
SNMM250924-HR	H	●	★	●	25.4	9.52	2.4	9.12	
SNMM190616-HV	H	★	●	★	19.05	6.35	1.6	7.93	
SNMM190624-HV	H	★	★	★	19.05	6.35	2.4	7.93	
SNMM250724-HV	H	★	●	●	25.4	7.94	2.4	9.12	
SNMM250924-HV	H	★	●	●	25.4	9.52	2.4	9.12	
SNMM120408-HZ	H	★	★	★	12.7	4.76	0.8	5.16	
SNMM120412-HZ	H	★	★	★	12.7	4.76	1.2	5.16	
SNMM150612-HZ	H	★	★	★	15.875	6.35	1.2	6.35	
SNMM190612-HZ	H	★	●	●	19.05	6.35	1.2	7.93	
SNMM190616-HZ	H	★	●	★	19.05	6.35	1.6	7.93	
SNMM150612-HM	H		★	★	15.875	6.35	1.2	6.35	
SNMM190612-HM	H		★	★	19.05	6.35	1.2	7.93	
SNMM190616-HM	H		●	★	19.05	6.35	1.6	7.93	
SNMM190624-HM	H		★	●	19.05	6.35	2.4	7.93	
SNMM250724-HM	H	★	★	●	25.4	7.94	2.4	9.12	
SNMM250924-HM	H	★	★	●	25.4	9.52	2.4	9.12	

3/3

(10 inserts in one case)



● : Inventory maintained. ★ : Inventory maintained in Japan.

TNMG, TNMX, TNMM

NEGATIVE INSERTS (WITH HOLE)

M Class

TNMG, TNMX, TNMM

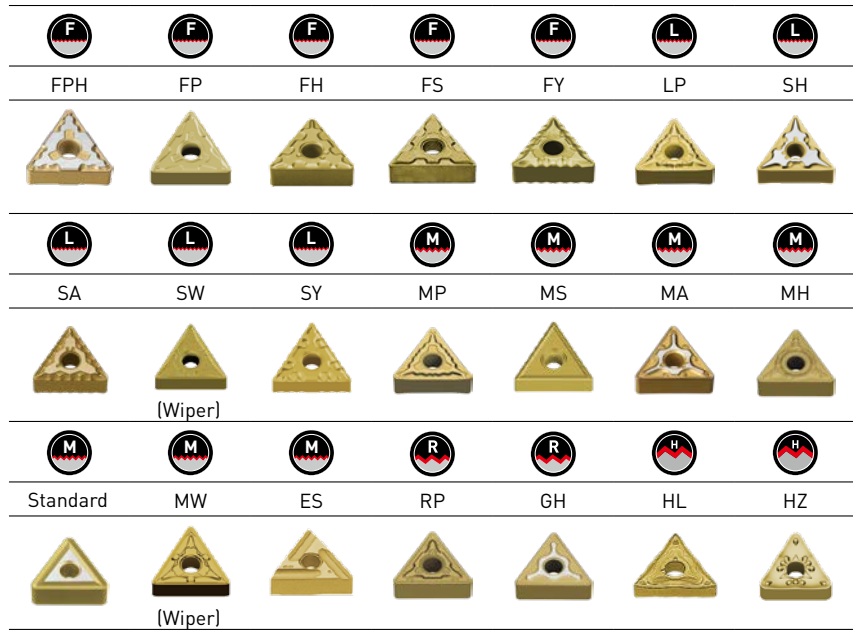
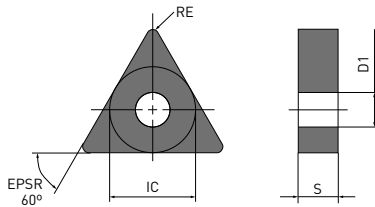

Order number			MC6115	MC6125	MC6135	IC	S	RE	D1
	F	L							
TNMG160404-FPH	F		●	●	●	9.525	4.76	0.4	3.81
TNMG160408-FPH	F		●	●	●	9.525	4.76	0.8	3.81
TNMG160412-FPH	F		●	●	●	9.525	4.76	1.2	3.81
TNMG160402-FP	F		★	★	★	9.525	4.76	0.2	3.81
TNMG160404-FP	F		●	★	★	9.525	4.76	0.4	3.81
TNMG160408-FP	F		★	★	★	9.525	4.76	0.8	3.81
TNMG160412-FP	F		★	★	★	9.525	4.76	1.2	3.81
TNMG160402-FH	F		★	★	★	9.525	4.76	0.2	3.81
TNMG160404-FH	F		●	★		9.525	4.76	0.4	3.81
TNMG160408-FH	F		●	★	★	9.525	4.76	0.8	3.81
TNMG160404-FS	F			★	★	9.525	4.76	0.4	3.81
TNMG160408-FS	F			★	★	9.525	4.76	0.8	3.81
TNMG160404-FY	F		●	●	★	9.525	4.76	0.4	3.81
TNMG160408-FY	F		●	★	★	9.525	4.76	0.8	3.81
TNMG160404-LP	L		●	●	★	9.525	4.76	0.4	3.81
TNMG160408-LP	L		●	●	★	9.525	4.76	0.8	3.81
TNMG160412-LP	L		●	●	★	9.525	4.76	1.2	3.81
TNMG220408-LP	L		●	●	★	12.7	4.76	0.8	5.16
TNMG220412-LP	L		●	●	★	12.7	4.76	1.2	5.16
TNMG160404-SH	L		★	★	★	9.525	4.76	0.4	3.81
TNMG160408-SH	L		★	★	★	9.525	4.76	0.8	3.81
TNMG220408-SH	L		★	★		12.7	4.76	0.8	5.16

(10 inserts in one case)



● / ★ = Expansion

● : Inventory maintained. ★ : Inventory maintained in Japan.

TNMG, TNMX, TNMM - NEGATIVE INSERTS (WITH HOLE)

Order number		MC6115	MC6125	MC6135	IC	S	RE	D1
TNMG160404-SA	L	★	★	★	9.525	4.76	0.4	3.81
TNMG160408-SA	L	★	★	★	9.525	4.76	0.8	3.81
TNMG160412-SA	L	★	●	★	9.525	4.76	1.2	3.81
TNMG220408-SA	L	●	★	★	12.7	4.76	0.8	5.16
TNMG220412-SA	L	★	★		12.7	4.76	1.2	5.16
TNMX160404-SW	L	●	●		9.525	4.76	0.4	3.81
TNMX160408-SW	L	●	●		9.525	4.76	0.8	3.81
TNMG160404-SY	L	●	★	★	9.525	4.76	0.4	3.81
TNMG160408-SY	L	●	●	★	9.525	4.76	0.8	3.81
TNMG160404-MP	M	●	●	★	9.525	4.76	0.4	3.81
TNMG160408-MP	M	●	●	★	9.525	4.76	0.8	3.81
TNMG160412-MP	M	●	●	★	9.525	4.76	1.2	3.81
TNMG220408-MP	M	●	●	★	12.7	4.76	0.8	5.16
TNMG220412-MP	M	●	●	★	12.7	4.76	1.2	5.16
TNMG160404-MS	M	★	★		9.525	4.76	0.4	3.81
TNMG160408-MS	M	★	★	★	9.525	4.76	0.8	3.81
TNMG160412-MS	M	★	★		9.525	4.76	1.2	3.81
TNMG220408-MS	M	★	★		12.7	4.76	0.8	5.16
TNMG160404-MA	M	●	●	★	9.525	4.76	0.4	3.81
TNMG160408-MA	M	●	●	●	9.525	4.76	0.8	3.81
TNMG160412-MA	M	●	●	★	9.525	4.76	1.2	3.81
TNMG220408-MA	M	●	●	★	12.7	4.76	0.8	5.16
TNMG220412-MA	M	●	●	★	12.7	4.76	1.2	5.16
TNMG270608-MA	M	★	★	★	15.875	6.35	0.8	6.35
TNMG270612-MA	M	★	★	★	15.875	6.35	1.2	6.35
TNMG160404-MH	M	★	●	★	9.525	4.76	0.4	3.81
TNMG160408-MH	M	●	●	★	9.525	4.76	0.8	3.81
TNMG160412-MH	M	●	●	★	9.525	4.76	1.2	3.81
TNMG220408-MH	M	●	●	★	12.7	4.76	0.8	5.16
TNMG220412-MH	M	●	●	★	12.7	4.76	1.2	5.16
TNMG110304	M	★	●	★	6.35	3.18	0.4	2.26
TNMG110308	M	★	★	★	6.35	3.18	0.8	2.26
TNMG160304	M	★	★	★	9.525	3.18	0.4	3.81
TNMG160308	M	★	★	★	9.525	3.18	0.8	3.81
TNMG160404	M	●	●	★	9.525	4.76	0.4	3.81
TNMG160408	M	●	●	★	9.525	4.76	0.8	3.81
TNMG160412	M	●	●	★	9.525	4.76	1.2	3.81
TNMG160416	M	★	★	★	9.525	4.76	1.6	3.81
TNMG220404	M	●	●	★	12.7	4.76	0.4	5.16
TNMG220408	M	●	●	★	12.7	4.76	0.8	5.16
TNMG220412	M	●	●	★	12.7	4.76	1.2	5.16
TNMG220416	M	★	★	★	12.7	4.76	1.6	5.16
TNMG270608	M	★	★	★	15.875	6.35	0.8	6.35
TNMG270612	M	★	★	★	15.875	6.35	1.2	6.35
TNMG270616	M	★	★	★	15.875	6.35	1.6	6.35

2/3

(10 inserts in one case)



● : Inventory maintained. ★ : Inventory maintained in Japan.

TNMG, TNMX, TNMM - NEGATIVE INSERTS (WITH HOLE)

Order number			MC6115	MC6125	MC6135	IC	S	RE	D1
TNMX160408-MW	M	●	●			9.525	4.76	0.8	3.81
TNMX160412-MW	M	●	●			9.525	4.76	1.2	3.81
TNMG160404R-ES	M	★	★			9.525	4.76	0.4	3.81
TNMG160404L-ES	M	★	★			9.525	4.76	0.4	3.81
TNMG160408R-ES	M	★	★			9.525	4.76	0.8	3.81
TNMG160408L-ES	M	★	★			9.525	4.76	0.8	3.81
TNMG220408R-ES	M	★	★			12.7	4.76	0.8	5.16
TNMG220408L-ES	M	★	★			12.7	4.76	0.8	5.16
TNMG160408-RP	R	●	●	★		9.525	4.76	0.8	3.81
TNMG160412-RP	R	●	●	★		9.525	4.76	1.2	3.81
TNMG220408-RP	R	●	●	●		12.7	4.76	0.8	5.16
TNMG220412-RP	R	●	●	★		12.7	4.76	1.2	5.16
TNMG220416-RP	R	●	●	★		12.7	4.76	1.6	5.16
TNMG270612-RP	R	★	★	★		15.875	6.35	1.2	6.35
TNMG270616-RP	R	★	★	★		15.875	6.35	1.6	6.35
TNMG160408-GH	R	★	★	★		9.525	4.76	0.8	3.81
TNMG160412-GH	R	★	★			9.525	4.76	1.2	3.81
TNMG220408-GH	R	★	★	★		12.7	4.76	0.8	5.16
TNMG220412-GH	R	★	★	★		12.7	4.76	1.2	5.16
TNMG220416-GH	R	★	★			12.7	4.76	1.6	5.16
TNMG270612-GH	R	★	★	★		15.875	6.35	1.2	6.35
TNMG270616-GH	R	★	★			15.875	6.35	1.6	6.35
TNMM160408-HL	H		●	★		9.525	4.76	0.8	3.81
TNMM160412-HL	H		●	●		9.525	4.76	1.2	3.81
TNMM220408-HL	H		●	★		12.7	4.76	0.8	5.16
TNMM220412-HL	H		●	●		12.7	4.76	1.2	5.16
TNMM220416-HL	H		★	★		12.7	4.76	1.6	5.16
TNMM160408-HZ	H	★	★	★		9.525	4.76	0.8	3.81
TNMM160412-HZ	H		★	★		9.525	4.76	1.2	3.81
TNMM220408-HZ	H	★	●	★		12.7	4.76	0.8	5.16
TNMM220412-HZ	H	★	●	★		12.7	4.76	1.2	5.16
TNMM220416-HZ	H	★	●	★		12.7	4.76	1.6	5.16

3/3

(10 inserts in one case)



VNMG

NEGATIVE INSERTS (WITH HOLE)

M Class

VNMG

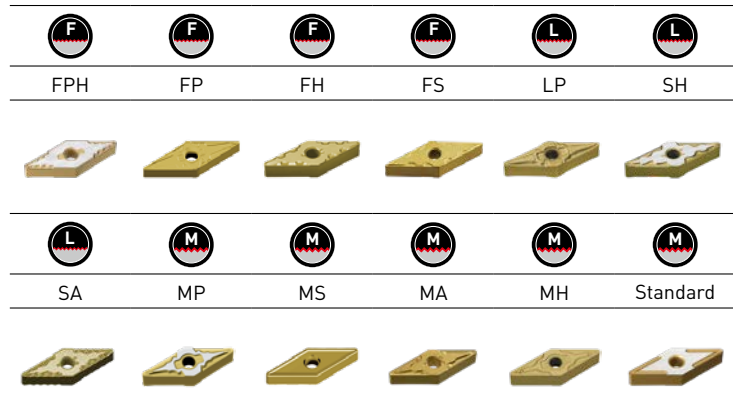
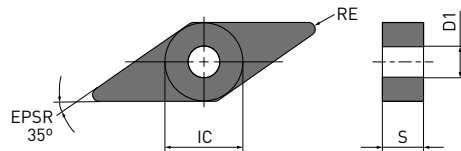

Order number		MC6115	MC6125	MC6135	IC	S	RE	D1
VNMG160404-FPH	F	●	●	●	9.525	4.76	0.4	3.81
VNMG160408-FPH	F	●	●	●	9.525	4.76	0.8	3.81
VNMG160412-FPH	F	●	●	●	9.525	4.76	1.2	3.81
VNMG160402-FP	F	★	★	★	9.525	4.76	0.2	3.81
VNMG160404-FP	F	●	★	★	9.525	4.76	0.4	3.81
VNMG160408-FP	F	★	★	★	9.525	4.76	0.8	3.81
VNMG160412-FP	F	★	★	★	9.525	4.76	1.2	3.81
VNMG160402-FH	F	★	★	★	9.525	4.76	0.2	3.81
VNMG160404-FH	F	★	★	★	9.525	4.76	0.4	3.81
VNMG160408-FH	F	★	★	★	9.525	4.76	0.8	3.81
VNMG160404-FS	F		★	★	9.525	4.76	0.4	3.81
VNMG160408-FS	F		★	★	9.525	4.76	0.8	3.81
VNMG160404-LP	L	●	●	★	9.525	4.76	0.4	3.81
VNMG160408-LP	L	●	●	★	9.525	4.76	0.8	3.81
VNMG160404-SH	L	★	★	★	9.525	4.76	0.4	3.81
VNMG160408-SH	L	★	★	★	9.525	4.76	0.8	3.81
VNMG160404-SA	L	★	★	★	9.525	4.76	0.4	3.81
VNMG160408-SA	L	★	●	★	9.525	4.76	0.8	3.81
VNMG160404-MP	M	●	●	★	9.525	4.76	0.4	3.81
VNMG160408-MP	M	●	●	●	9.525	4.76	0.8	3.81
VNMG160412-MP	M	●	●	★	9.525	4.76	1.2	3.81
VNMG160404-MS	M	★	●		9.525	4.76	0.4	3.81
VNMG160408-MS	M	★	★		9.525	4.76	0.8	3.81
VNMG160404-MA	M	●	●	★	9.525	4.76	0.4	3.81
VNMG160408-MA	M	●	●	★	9.525	4.76	0.8	3.81
VNMG160404-MH	M	★	★	★	9.525	4.76	0.4	3.81
VNMG160408-MH	M	●	●	★	9.525	4.76	0.8	3.81
VNMG160404	M	●	●	★	9.525	4.76	0.4	3.81
VNMG160408	M	●	●	★	9.525	4.76	0.8	3.81
VNMG160412	M	●	●	★	9.525	4.76	1.2	3.81

1/1

(10 inserts in one case)

● / ★ = Expansion

● : Inventory maintained. ★ : Inventory maintained in Japan.





WNMG

NEGATIVE INSERTS (WITH HOLE)

M Class

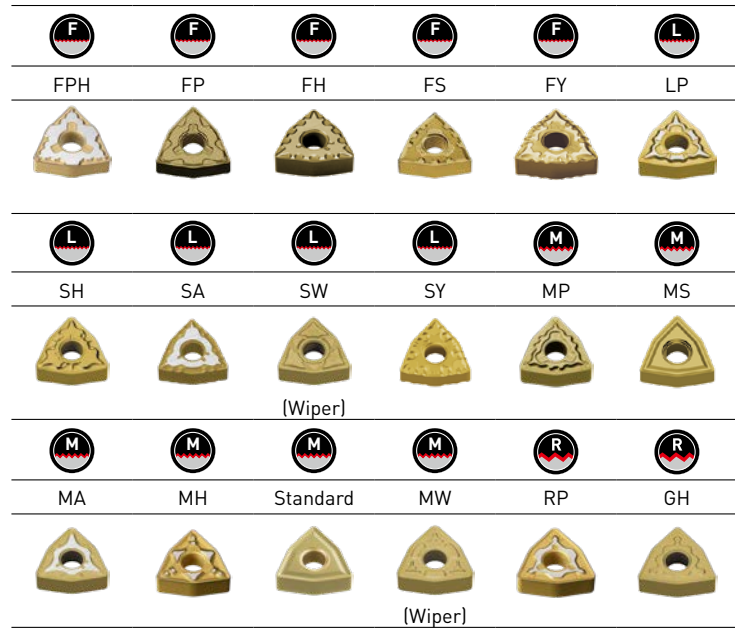
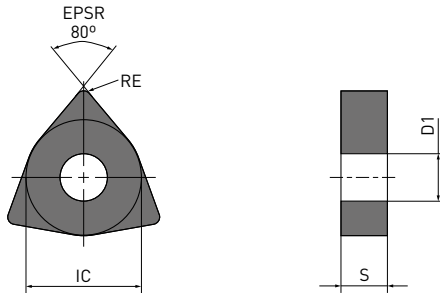
WNMG



Order number	 		MC6115	MC6125	MC6135	IC	S	RE	D1
	F	L							
WNMG080404-FPH	F		●	●	●	12.7	4.76	0.4	5.16
WNMG080408-FPH	F		●	●	●	12.7	4.76	0.8	5.16
WNMG080412-FPH	F		●	●	●	12.7	4.76	1.2	5.16
WNMG080402-FP	F		★	★	★	12.7	4.76	0.2	5.16
WNMG080404-FP	F		★	★	★	12.7	4.76	0.4	5.16
WNMG080408-FP	F		★	★	★	12.7	4.76	0.8	5.16
WNMG080412-FP	F		★	★	★	12.7	4.76	1.2	5.16
WNMG080404-FH	F		★	★		12.7	4.76	0.4	5.16
WNMG080408-FH	F		★	★		12.7	4.76	0.8	5.16
WNMG080404-FS	F			★	★	12.7	4.76	0.4	5.16
WNMG080408-FS	F			★	★	12.7	4.76	0.8	5.16
WNMG080408-FY	F		★	★	★	12.7	4.76	0.8	5.16
WNMG06T304-LP	L		★	★	●	9.525	3.97	0.4	3.81
WNMG06T308-LP	L		●	★	●	9.525	3.97	0.8	3.81
WNMG060404-LP	L		●	●	●	9.525	4.76	0.4	3.81
WNMG060408-LP	L		●	●	●	9.525	4.76	0.8	3.81
WNMG080404-LP	L		●	●	★	12.7	4.76	0.4	5.16
WNMG080408-LP	L		●	●	★	12.7	4.76	0.8	5.16
WNMG080412-LP	L		●	●	★	12.7	4.76	1.2	5.16
WNMG06T304-SH	L		●	●		9.525	3.97	0.4	3.81
WNMG06T308-SH	L		●	●		9.525	3.97	0.8	3.81
WNMG060404-SH	L		★	●		9.525	4.76	0.4	3.81
WNMG060408-SH	L		●	★		9.525	4.76	0.8	3.81
WNMG080404-SH	L		★	★	★	12.7	4.76	0.4	5.16
WNMG080408-SH	L		★	★	★	12.7	4.76	0.8	5.16
WNMG080412-SH	L		★	★	★	12.7	4.76	1.2	5.16

(10 inserts in one case)

● / ★ = Expansion

● : Inventory maintained. ★ : Inventory maintained in Japan.

WNMG – NEGATIVE INSERTS (WITH HOLE)

Order number		MC6115	MC6125	MC6135	IC	S	RE	D1
WNMG080404-SA	L	★	★	★	12.7	4.76	0.4	5.16
WNMG080408-SA	L	★	★	★	12.7	4.76	0.8	5.16
WNMG080412-SA	L	★	★	★	12.7	4.76	1.2	5.16
WNMG060404-SW	L	●	★		9.525	4.76	0.4	3.81
WNMG060408-SW	L	●	●		9.525	4.76	0.8	3.81
WNMG080404-SW	L	●	★		12.7	4.76	0.4	5.16
WNMG080408-SW	L	●	★		12.7	4.76	0.8	5.16
WNMG080412-SW	L	●	★		12.7	4.76	1.2	5.16
WNMG080408-SY	L	●	●	★	12.7	4.76	0.8	5.16
WNMG06T304-MP	M	●	●	●	9.525	3.97	0.4	3.81
WNMG06T308-MP	M	●	●	●	9.525	3.97	0.8	3.81
WNMG06T312-MP	M	●	●	●	9.525	3.97	1.2	3.81
WNMG060404-MP	M	●	●	●	9.525	4.76	0.4	3.81
WNMG060408-MP	M	●	●	●	9.525	4.76	0.8	3.81
WNMG060412-MP	M	●	●	●	9.525	4.76	1.2	3.81
WNMG080404-MP	M	●	●	★	12.7	4.76	0.4	5.16
WNMG080408-MP	M	●	●	●	12.7	4.76	0.8	5.16
WNMG080412-MP	M	●	●	★	12.7	4.76	1.2	5.16
WNMG080416-MP	M	●	●	★	12.7	4.76	1.6	5.16
WNMG06T304-MS	M	★	●		9.525	3.97	0.4	3.81
WNMG06T308-MS	M	★	★		9.525	3.97	0.8	3.81
WNMG060404-MS	M	★	★		9.525	4.76	0.4	3.81
WNMG060408-MS	M	★	★		9.525	4.76	0.8	3.81
WNMG080404-MS	M	★	★	★	12.7	4.76	0.4	5.16
WNMG080408-MS	M	★	★	★	12.7	4.76	0.8	5.16
WNMG080412-MS	M	★	★		12.7	4.76	1.2	5.16
WNMG06T304-MA	M	★	●		9.525	3.97	0.4	3.81
WNMG06T308-MA	M	★	●		9.525	3.97	0.8	3.81
WNMG06T312-MA	M	★	★		9.525	3.97	1.2	3.81
WNMG060404-MA	M	●	●	★	9.525	4.76	0.4	3.81
WNMG060408-MA	M	●	●	★	9.525	4.76	0.8	3.81
WNMG060412-MA	M	★	●	★	9.525	4.76	1.2	3.81
WNMG080404-MA	M	●	●	★	12.7	4.76	0.4	5.16
WNMG080408-MA	M	●	●	●	12.7	4.76	0.8	5.16
WNMG080412-MA	M	●	●	★	12.7	4.76	1.2	5.16
WNMG080416-MA	M	●	●		12.7	4.76	1.6	5.16
WNMG100612-MA	M		★	★	15.875	6.35	1.2	6.35
WNMG080404-MH	M	★	●	★	12.7	4.76	0.4	5.16
WNMG080408-MH	M	●	●	★	12.7	4.76	0.8	5.16
WNMG080412-MH	M	●	●	★	12.7	4.76	1.2	5.16
WNMG080404	M	●	●	★	12.7	4.76	0.4	5.16
WNMG080408	M	●	●	★	12.7	4.76	0.8	5.16
WNMG080412	M	●	●	★	12.7	4.76	1.2	5.16
WNMG060408-MW	M	●	●	★	9.525	4.76	0.8	3.81
WNMG060412-MW	M	●	●	★	9.525	4.76	1.2	3.81
WNMG080408-MW	M	●	●	★	12.7	4.76	0.8	5.16
WNMG080412-MW	M	●	●	★	12.7	4.76	1.2	5.16

2/3

(10 inserts in one case)



● : Inventory maintained. ★ : Inventory maintained in Japan.

WNMG – NEGATIVE INSERTS (WITH HOLE)

Order number		MC6115	MC6125	MC6135	IC	S	RE	D1
WNMG080408-RP	R	●	●	●	12.7	4.76	0.8	5.16
WNMG080412-RP	R	●	●	●	12.7	4.76	1.2	5.16
WNMG080416-RP	R	●	●		12.7	4.76	1.6	5.16
WNMG080408-GH	R	★	●	★	12.7	4.76	0.8	5.16
WNMG080412-GH	R	★	●	★	12.7	4.76	1.2	5.16

3/3

(10 inserts in one case)





VBMT

5° POSITIVE INSERTS (WITH HOLE)

M Class

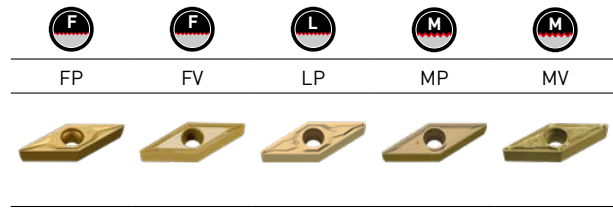
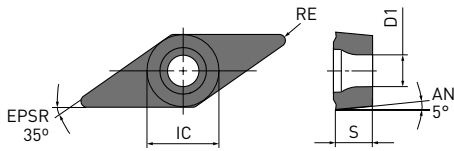
VBMT



Order number			MC6115	MC6125	MC6135	IC	S	RE	D1
									
VBMT110302-FP	F		●	●	★	6.35	3.18	0.2	2.9
VBMT110304-FP	F		●	●	★	6.35	3.18	0.4	2.9
VBMT110308-FP	F		●	★	★	6.35	3.18	0.8	2.9
VBMT160404-FP	F		●	●	★	9.525	4.76	0.4	4.4
VBMT160408-FP	F		●	●	★	9.525	4.76	0.8	4.4
VBMT160412-FP	F		●	●	●	9.525	4.76	1.2	4.4
VBMT110304-FV	F		●	●	★	6.35	3.18	0.4	2.9
VBMT110308-FV	F			●	★	6.35	3.18	0.8	2.9
VBMT160404-FV	F		●	●	★	9.525	4.76	0.4	4.4
VBMT160408-FV	F		●	●	★	9.525	4.76	0.8	4.4
VBMT110304-LP	L		●	●	★	6.35	3.18	0.4	2.9
VBMT110308-LP	L		●	●	★	6.35	3.18	0.8	2.9
VBMT160404-LP	L		●	●	★	9.525	4.76	0.4	4.4
VBMT160408-LP	L		●	●	★	9.525	4.76	0.8	4.4
VBMT160412-LP	L		●	●	●	9.525	4.76	1.2	4.4
VBMT160404-MP	M		●	●	★	9.525	4.76	0.4	4.4
VBMT160408-MP	M		●	●	★	9.525	4.76	0.8	4.4
VBMT110304-MV	M			●	★	6.35	3.18	0.4	2.9
VBMT110308-MV	M			●	★	6.35	3.18	0.8	2.9
VBMT160404-MV	M			●	★	9.525	4.76	0.4	4.4
VBMT160408-MV	M			★	★	9.525	4.76	0.8	4.4

1/1

{10 inserts in one case}



TBMT, WBMT

5° POSITIVE INSERTS (WITH HOLE)

M Class

TBMT

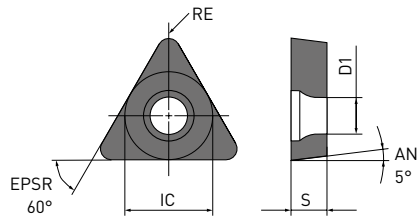

FV



MV



WBMT

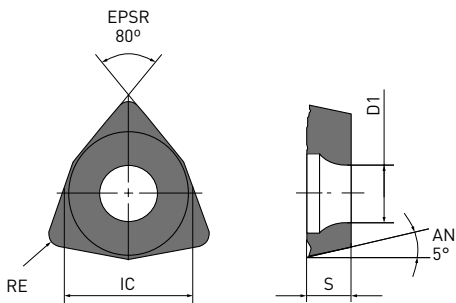

Order number			MC6115	MC6125	MC6135	IC	S	RE	D1
	F	M							
TBMT060102-FV	F		●		●	3.97	1.59	0.2	2.3
TBMT060104-FV	F		●		●	3.97	1.59	0.4	2.3
WBMTL30202R-MV		M		●	★	4.76	2.38	0.2	2.3
WBMTL30202L-MV		M		★	★	4.76	2.38	0.2	2.3
WBMTL30204R-MV		M		★	★	4.76	2.38	0.4	2.3
WBMTL30204L-MV		M		★	★	4.76	2.38	0.4	2.3

1/1

(10 inserts in one case)





CCMT, CCMH

7° POSITIVE INSERTS (WITH HOLE)

M Class

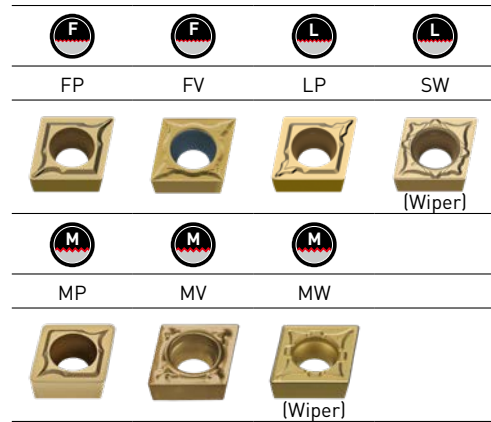
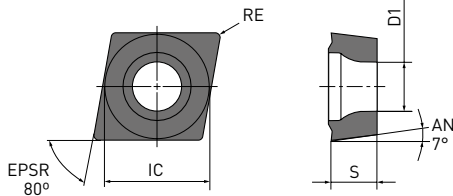
CCMT, CCMH



Order number			MC6115	MC6125	MC6135	IC	S	RE	D1
	R	H							
CCMT060202-FP	F		●	●	★	6.35	2.38	0.2	2.8
CCMT060204-FP	F		●	●	★	6.35	2.38	0.4	2.8
CCMT09T302-FP	F		●	●	★	9.525	3.97	0.2	4.4
CCMT09T304-FP	F		●	●	★	9.525	3.97	0.4	4.4
CCMT09T308-FP	F		●	●	★	9.525	3.97	0.8	4.4
CCMT060202-FV	F			●	★	6.35	2.38	0.2	2.8
CCMT060204-FV	F			●	★	6.35	2.38	0.4	2.8
CCMT09T302-FV	F			●	★	9.525	3.97	0.2	4.4
CCMT09T304-FV	F			●	★	9.525	3.97	0.4	4.4
CCMT09T308-FV	F			●	★	9.525	3.97	0.8	4.4
CCMT060202-LP	L		●	●	★	6.35	2.38	0.2	2.8
CCMT060204-LP	L		●	●	★	6.35	2.38	0.4	2.8
CCMT060208-LP	L		●	●	★	6.35	2.38	0.8	2.8
CCMT09T302-LP	L		●	●	●	9.525	3.97	0.2	4.4
CCMT09T304-LP	L		●	●	★	9.525	3.97	0.4	4.4
CCMT09T308-LP	L		●	●	★	9.525	3.97	0.8	4.4
CCMT060202-SW	L		●	●	★	6.35	2.38	0.2	2.8
CCMT060204-SW	L		●	●	★	6.35	2.38	0.4	2.8
CCMT060208-SW	L		●	●	●	6.35	2.38	0.8	2.8
CCMT09T302-SW	L		●	●	★	9.525	3.97	0.2	4.4
CCMT09T304-SW	L		●	●	★	9.525	3.97	0.4	4.4
CCMT09T308-SW	L		●	●	●	9.525	3.97	0.8	4.4

1/2

(10 inserts in one case)



CCMT, CCMH - 7° POSITIVE INSERTS (WITH HOLE)

Order number		MC6115	MC6125	MC6135	IC	S	RE	D1
CCMT060202-MP	M	●	●	★	6.35	2.38	0.2	2.8
CCMT060204-MP	M	●	●	★	6.35	2.38	0.4	2.8
CCMT060208-MP	M	●	●	★	6.35	2.38	0.8	2.8
CCMT080302-MP	M	★	★		7.94	3.18	0.2	3.4
CCMT080304-MP	M	●	★		7.94	3.18	0.4	3.4
CCMT080308-MP	M	●	★		7.94	3.18	0.8	3.4
CCMT09T302-MP	M	●	●	★	9.525	3.97	0.2	4.4
CCMT09T304-MP	M	●	●	★	9.525	3.97	0.4	4.4
CCMT09T308-MP	M	●	●	★	9.525	3.97	0.8	4.4
CCMT120404-MP	M	●	●	★	12.7	4.76	0.4	5.5
CCMT120408-MP	M	●	●	★	12.7	4.76	0.8	5.5
CCMT120412-MP	M	●	●	★	12.7	4.76	1.2	5.5
CCMH060202-MV	M		●	★	6.35	2.38	0.2	2.8
CCMH060204-MV	M		●	★	6.35	2.38	0.4	2.8
CCMT060204-MW	M	●	●	★	6.35	2.38	0.4	2.8
CCMT060208-MW	M	●	●	★	6.35	2.38	0.8	2.8
CCMT09T304-MW	M	●	●	★	9.525	3.97	0.4	4.4
CCMT09T308-MW	M	●	●	★	9.525	3.97	0.8	4.4
CCMT120404-MW	M	●	●	★	12.7	4.76	0.4	5.5
CCMT120408-MW	M	●	●	★	12.7	4.76	0.8	5.5

2/2

(10 inserts in one case)





DCMT, DCMX

7° POSITIVE INSERTS (WITH HOLE)

M Class

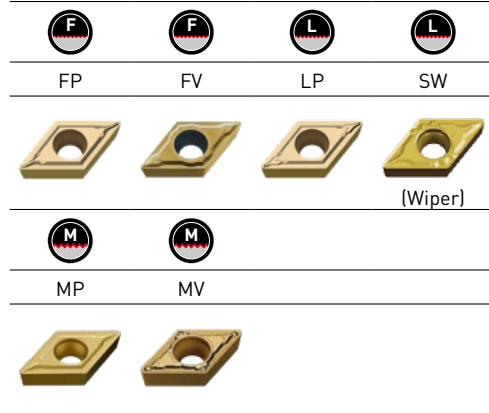
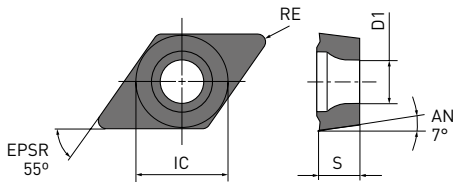
DCMT, DCMX



Order number			MC6115	MC6125	MC6135	IC	S	RE	D1
	F	L							
DCMT070202-FP	F		●	●	★	6.35	2.38	0.2	2.8
DCMT070204-FP	F		●	●	★	6.35	2.38	0.4	2.8
DCMT11T302-FP	F		●	●	★	9.525	3.97	0.2	4.4
DCMT11T304-FP	F		●	●	★	9.525	3.97	0.4	4.4
DCMT11T308-FP	F		●	●	★	9.525	3.97	0.8	4.4
DCMT070202-FV	F		●	●	★	6.35	2.38	0.2	2.8
DCMT070204-FV	F		●	●	★	6.35	2.38	0.4	2.8
DCMT070208-FV	F			●	★	6.35	2.38	0.8	2.8
DCMT11T302-FV	F			●	★	9.525	3.97	0.2	4.4
DCMT11T304-FV	F		●	●	★	9.525	3.97	0.4	4.4
DCMT11T308-FV	F		●	●	★	9.525	3.97	0.8	4.4
DCMT070202-LP	L		●	●	★	6.35	2.38	0.2	2.8
DCMT070204-LP	L		●	●	★	6.35	2.38	0.4	2.8
DCMT070208-LP	L		●	●	★	6.35	2.38	0.8	2.8
DCMT11T302-LP	L		●	●	★	9.525	3.97	0.2	4.4
DCMT11T304-LP	L		●	●	★	9.525	3.97	0.4	4.4
DCMT11T308-LP	L		●	●	★	9.525	3.97	0.8	4.4
DCMX070202-SW	L		●	●	●	6.35	2.38	0.2	2.8
DCMX070204-SW	L		●	●	●	6.35	2.38	0.4	2.8
DCMX070208-SW	L		●	●	●	6.35	2.38	0.8	2.8
DCMX11T302-SW	L		●	●	●	9.525	3.97	0.2	4.4
DCMX11T304-SW	L		●	●	●	9.525	3.97	0.4	4.4
DCMX11T308-SW	L		●	●	●	9.525	3.97	0.8	4.4

1/2

(10 inserts in one case)



DCMT, DCMX – 7° POSITIVE INSERTS (WITH HOLE)

Order number		M	MC6115	MC6125	MC6135	IC	S	RE	D1
			●	●	★				
DCMT070202-MP	M	●	●	★	6.35	2.38	0.2	2.8	
DCMT070204-MP	M	●	●	★	6.35	2.38	0.4	2.8	
DCMT070208-MP	M	●	●	★	6.35	2.38	0.8	2.8	
DCMT11T302-MP	M	●	●	★	9.525	3.97	0.2	4.4	
DCMT11T304-MP	M	●	●	★	9.525	3.97	0.4	4.4	
DCMT11T308-MP	M	●	●	★	9.525	3.97	0.8	4.4	
DCMT11T312-MP	M	●	●		9.525	3.97	1.2	4.4	
DCMT150404-MP	M	●	●	★	12.7	4.76	0.4	5.5	
DCMT150408-MP	M	●	●	★	12.7	4.76	0.8	5.5	
DCMT150412-MP	M	●	●		12.7	4.76	1.2	5.5	
DCMT070202-MV	M	●	●	★	6.35	2.38	0.2	2.8	
DCMT070204-MV	M	●	●	★	6.35	2.38	0.4	2.8	
DCMT070208-MV	M	●	●	★	6.35	2.38	0.8	2.8	
DCMT11T302-MV	M	●	●	★	9.525	3.97	0.2	4.4	
DCMT11T304-MV	M	●	●	★	9.525	3.97	0.4	4.4	
DCMT11T308-MV	M	●	★	★	9.525	3.97	0.8	4.4	

2/2

[10 inserts in one case]



RCMT, RCMX, SCMT

7° POSITIVE INSERTS (WITH HOLE)

M Class

RCMT, RCMX

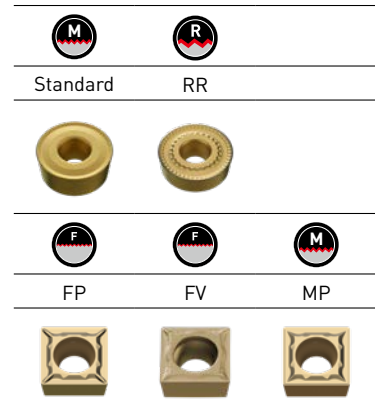
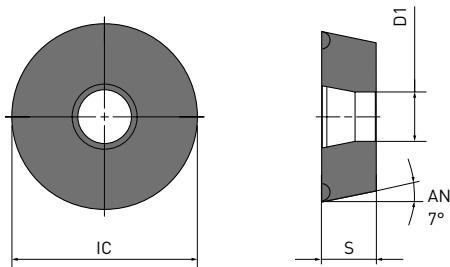

SCMT

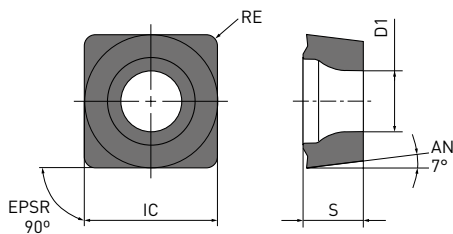

Order number			MC6115	MC6125	MC6135	IC	S	RE	D1
RCMT0602M0	M	M	●	●		6	2.38	—	2.8
RCMT0803M0	M	M	●	●		8	3.18	—	3.4
RCMX1003M0	M	M	●	●	★	10	3.18	—	3.6
RCMX1204M0	M	M	★	●	★	12	4.76	—	4.2
RCMX1606M0	M	M	★	●	★	16	6.35	—	5.2
RCMX2006M0	M	M	●	●	●	20	6.35	—	6.5
RCMX2507M0	M	M	★	●	★	25	7.94	—	7.2
RCMX3209M0	M	M	★	★	★	32	9.52	—	9.5
RCMX1606M0-RR	R	R	★	●	●	16	6.35	—	5.2
RCMX2006M0-RR	R	R	●	★	●	20	6.35	—	6.5
RCMX2507M0-RR	R	R	★	●	●	25	7.94	—	7.2
RCMX3209M0-RR	R	R	★	★	★	32	9.52	—	9.5
SCMT09T304-FP	F	F	●	●	★	9.525	3.97	0.4	4.4
SCMT09T308-FP	F	F	●	●	★	9.525	3.97	0.8	4.4
SCMT09T304-FV	F	F		●	★	9.525	3.97	0.4	4.4
SCMT09T304-LP	L	L	●	●	★	9.525	3.97	0.4	4.4
SCMT09T308-LP	L	L	●	●	★	9.525	3.97	0.8	4.4
SCMT09T304-MP	M	M	●	●	★	9.525	3.97	0.4	4.4
SCMT09T308-MP	M	M	●	●	★	9.525	3.97	0.8	4.4
SCMT120404-MP	M	M	●	●	★	12.7	4.76	0.4	5.5
SCMT120408-MP	M	M	●	●	★	12.7	4.76	0.8	5.5
SCMT120412-MP	M	M	●	★		12.7	4.76	1.2	5.5

1/1

[10 inserts in one case]



● : Inventory maintained. ★ : Inventory maintained in Japan.





TCMT, TCMX

7° POSITIVE INSERTS (WITH HOLE)

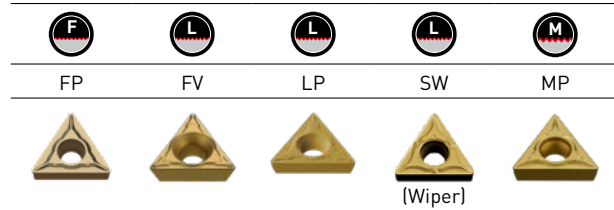
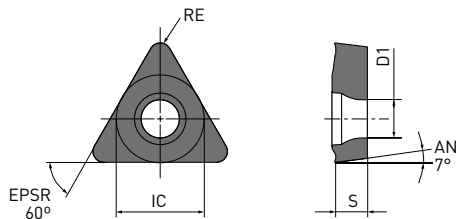
M Class

TCMT, TCMX



Order number	  		MC6115	MC6125	MC6135	IC	S	RE	D1
	 								
TCMT090202-FP	F		●	★	★	5.56	2.38	0.2	2.5
TCMT090204-FP	F		●	●	★	5.56	2.38	0.4	2.5
TCMT110202-FP	F		●	★	★	6.35	2.38	0.2	2.8
TCMT110204-FP	F		●	●	★	6.35	2.38	0.4	2.8
TCMT16T304-FP	F		●	●	★	9.525	3.97	0.4	4.4
TCMT110204-FV	F			●	★	6.35	2.38	0.4	2.8
TCMT16T304-FV	F			●	★	9.525	3.97	0.4	4.4
TCMT090204-LP	L		●	●	★	5.56	2.38	0.4	2.5
TCMT090208-LP	L		●	★	★	5.56	2.38	0.8	2.5
TCMT110202-LP	L		●	●	●	6.35	2.38	0.2	2.8
TCMT110204-LP	L		●	●	★	6.35	2.38	0.4	2.8
TCMT110208-LP	L		●	●	★	6.35	2.38	0.8	2.8
TCMT16T304-LP	L		●	●	★	9.525	3.97	0.4	4.4
TCMT16T308-LP	L		●	●	★	9.525	3.97	0.8	4.4
TCMX090204-SW	L		●	●	●	5.56	2.38	0.4	2.5
TCMX110204-SW	L		●	●	●	6.35	2.38	0.4	2.8
TCMT090204-MP	M		●	★	★	5.56	2.38	0.4	2.5
TCMT090208-MP	M		●	★	★	5.56	2.38	0.8	2.5
TCMT110202-MP	M		●	●	★	6.35	2.38	0.2	2.8
TCMT110204-MP	M		●	★	★	6.35	2.38	0.4	2.8
TCMT110208-MP	M		●	★	★	6.35	2.38	0.8	2.8
TCMT130304-MP	M		●	●	★	7.94	3.18	0.4	3.4
TCMT16T304-MP	M		●	●	★	9.525	3.97	0.4	4.4
TCMT16T308-MP	M		●	●	★	9.525	3.97	0.8	4.4
TCMT16T312-MP	M		●	●	★	9.525	3.97	1.2	4.4

1/1

(10 inserts in one case)



VCMT

7° POSITIVE INSERTS (WITH HOLE)

M Class

VCMT

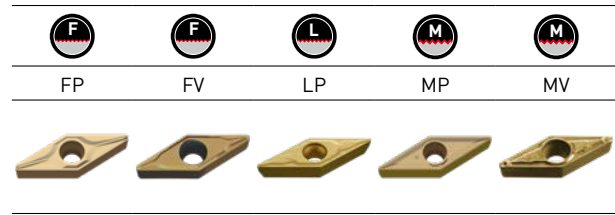
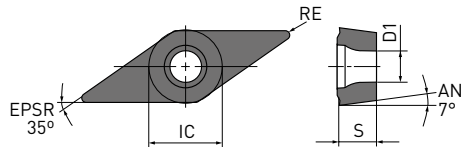

Order number			MC6115	MC6125	MC6135	IC	S	RE	D1
	F	L							
VCMT080202-FP	F		●	●	●	4.76	2.38	0.2	2.4
VCMT080204-FP	F		●	●	●	4.76	2.38	0.4	2.4
VCMT110302-FP	F		●	●	★	6.35	3.18	0.2	2.8
VCMT110304-FP	F		●	●	★	6.35	3.18	0.4	2.8
VCMT160404-FP	F		●	●	★	9.525	4.76	0.4	4.4
VCMT160408-FP	F		●	●	★	9.525	4.76	0.8	4.4
VCMT080202-FV	F			●	★	4.76	2.38	0.2	2.4
VCMT080204-FV	F			●	★	4.76	2.38	0.4	2.4
VCMT160404-FV	F		●	●	★	9.525	4.76	0.4	4.4
VCMT160408-FV	F		●	●	★	9.525	4.76	0.8	4.4
VCMT080202-LP	L		●	★	★	4.76	2.38	0.2	2.4
VCMT080204-LP	L		●	●	★	4.76	2.38	0.4	2.4
VCMT110304-LP	L		●	●	★	6.35	3.18	0.4	2.8
VCMT110308-LP	L		●	●	★	6.35	3.18	0.8	2.8
VCMT160404-LP	L		●	●	★	9.525	4.76	0.4	4.4
VCMT160408-LP	L		●	●	★	9.525	4.76	0.8	4.4
VCMT110304-MP	M		●	●	★	6.35	3.18	0.4	2.8
VCMT160404-MP	M		●	●	★	9.525	4.76	0.4	4.4
VCMT160408-MP	M		●	●	★	9.525	4.76	0.8	4.4
VCMT160412-MP	M		●	★	★	9.525	4.76	1.2	4.4
VCMT080202-MV	M			★	★	4.76	2.38	0.2	2.4
VCMT080204-MV	M			●	★	4.76	2.38	0.4	2.4

1/1

(10 inserts in one case)



WCMT, XCMT

7° POSITIVE INSERTS (WITH HOLE)

M Class

WCMT

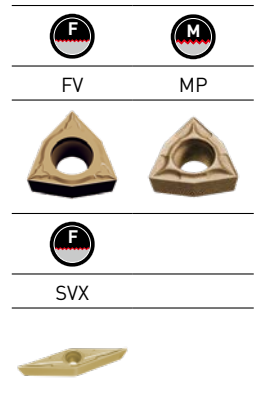
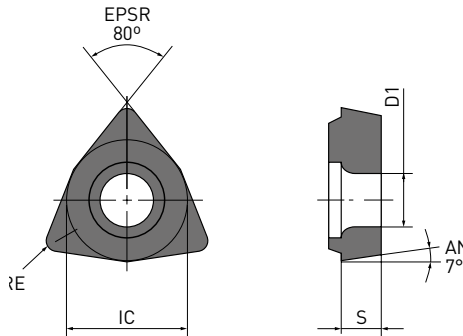

XCMT

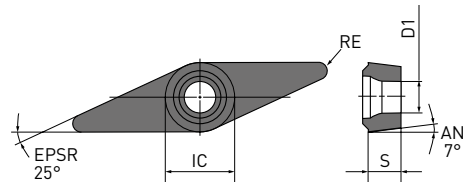

Order number			MC6115	MC6125	MC6135	IC	S	RE	D1
	F	M							
WCMT020102-FV	F			●		3.97	1.59	0.2	2.3
WCMT020104-FV	F			●		3.97	1.59	0.4	2.3
WCMTL30202-FV	F			●		4.76	2.38	0.2	2.3
WCMTL30204-FV	F			●		4.76	2.38	0.4	2.3
WCMT040202-FV	F			●		6.35	2.38	0.2	2.8
WCMT040204-FV	F			●		6.35	2.38	0.4	2.8
WCMT06T302-FV	F			●		9.525	3.97	0.2	4.4
WCMT06T304-FV	F			●		9.525	3.97	0.4	4.4
WCMT020102-MP	M		★	★	★	3.97	1.59	0.2	2.3
WCMT020104-MP	M		★	★	★	3.97	1.59	0.4	2.3
WCMTL30202-MP	M		★	★		4.76	2.38	0.2	2.3
WCMTL30204-MP	M		★	★		4.76	2.38	0.4	2.3
WCMT040202-MP	M		★	★	★	6.35	2.38	0.2	2.8
WCMT040204-MP	M		★	★	★	6.35	2.38	0.4	2.8
WCMT040208-MP	M			★	★	6.35	2.38	0.8	2.8
WCMT06T304-MP	M		★	★	★	9.525	3.97	0.4	4.4
WCMT06T308-MP	M		★	★	★	9.525	3.97	0.8	4.4
XCMT150304-SVX	F			●	★	6.35	3.18	0.4	2.85
XCMT150308-SVX	F			●	★	6.35	3.18	0.8	2.85

1/1

(10 inserts in one case)



CPMH

11° POSITIVE INSERTS (WITH HOLE)

M Class

CPMH

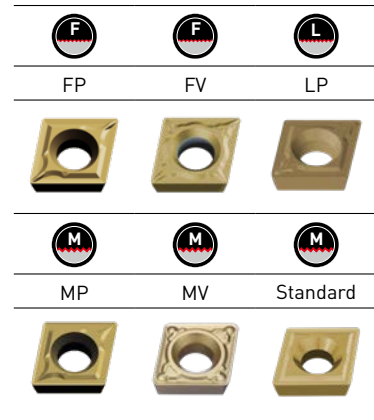
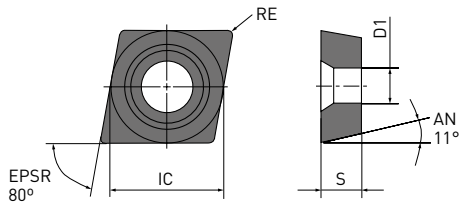

Order number			MC6115	MC6125	MC6135	IC	S	RE	D1
	F	L							
CPMH080202-FP	F			●	●	7.94	2.38	0.2	3.5
CPMH080204-FP	F			●	●	7.94	2.38	0.4	3.5
CPMH090302-FP	F			●	●	9.525	3.18	0.2	4.5
CPMH090304-FP	F			●	●	9.525	3.18	0.4	4.5
CPMH090308-FP	F			●	●	9.525	3.18	0.8	4.5
CPMH080202-FV	F			★	★	7.94	2.38	0.2	3.5
CPMH080204-FV	F			●	★	7.94	2.38	0.4	3.5
CPMH090302-FV	F			★	★	9.525	3.18	0.2	4.5
CPMH090304-FV	F			●	★	9.525	3.18	0.4	4.5
CPMH090308-FV	F			●	★	9.525	3.18	0.8	4.5
CPMH080202-LP		L		●	★	7.94	2.38	0.2	3.5
CPMH080204-LP		L	●	●	★	7.94	2.38	0.4	3.5
CPMH080208-LP		L	●	●	●	7.94	2.38	0.8	3.5
CPMH090302-LP		L		●	★	9.525	3.18	0.2	4.5
CPMH090304-LP		L	●	★	★	9.525	3.18	0.4	4.5
CPMH090308-LP		L	●	★	★	9.525	3.18	0.8	4.5
CPMH080204-MP	M		●	●	●	7.94	2.38	0.4	3.5
CPMH080208-MP	M		●	●	●	7.94	2.38	0.8	3.5
CPMH090304-MP	M		●	●	●	9.525	3.18	0.4	4.5
CPMH090308-MP	M		●	●	●	9.525	3.18	0.8	4.5
CPMH080204-MV	M			●	★	7.94	2.38	0.4	3.5
CPMH080208-MV	M			●	★	7.94	2.38	0.8	3.5
CPMH090304-MV	M			●	★	9.525	3.18	0.4	4.5
CPMH090308-MV	M			●	★	9.525	3.18	0.8	4.5
CPMH080204	M		★	●		7.94	2.38	0.4	3.5
CPMH080208	M		★	●		7.94	2.38	0.8	3.5
CPMH090304	M		★	●		9.525	3.18	0.4	4.5
CPMH090308	M		★	●	★	9.525	3.18	0.8	4.5

1/1

[10 inserts in one case]



● : Inventory maintained. ★ : Inventory maintained in Japan.

TPMH, TPMX

11° POSITIVE INSERTS (WITH HOLE)

M Class

TPMH, TPMX

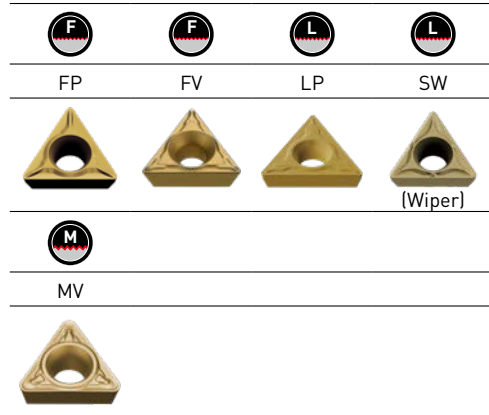
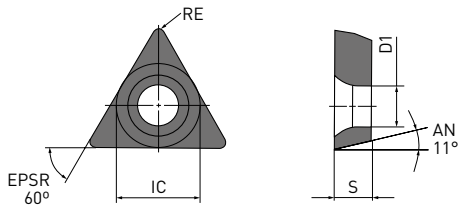

Order number			MC6115	MC6125	MC6135	IC	S	RE	D1
	F	L							
TPMH090202-FP	F		●	●	●	5.56	2.38	0.2	2.9
TPMH090204-FP	F		●	●	●	5.56	2.38	0.4	2.9
TPMH110302-FP	F		●	●	●	6.35	3.18	0.2	3.4
TPMH110304-FP	F		●	●	●	6.35	3.18	0.4	3.4
TPMH110308-FP	F		●	●	●	6.35	3.18	0.8	3.4
TPMH080202-FV	F			★	★	4.76	2.38	0.2	2.4
TPMH080204-FV	F			★	★	4.76	2.38	0.4	2.4
TPMH090202-FV	F			★	★	5.56	2.38	0.2	2.9
TPMH090204-FV	F			●	★	5.56	2.38	0.4	2.9
TPMH110302-FV	F			★	★	6.35	3.18	0.2	3.4
TPMH110304-FV	F		●	●	★	6.35	3.18	0.4	3.4
TPMH110308-FV	F		●	●	★	6.35	3.18	0.8	3.4
TPMH160302-FV	F			●	★	9.525	3.18	0.2	4.4
TPMH160304-FV	F		●	★	★	9.525	3.18	0.4	4.4
TPMH160308-FV	F			●	★	9.525	3.18	0.8	4.4
TPMH080202-LP	L			●	★	4.76	2.38	0.2	2.4
TPMH080204-LP	L			●	★	4.76	2.38	0.4	2.4
TPMH090202-LP	L		●	★	★	5.56	2.38	0.2	2.9
TPMH090204-LP	L		●	●	★	5.56	2.38	0.4	2.9
TPMH110302-LP	L		●	★	★	6.35	3.18	0.2	3.4
TPMH110304-LP	L		●	●	★	6.35	3.18	0.4	3.4
TPMH110308-LP	L		●	★	★	6.35	3.18	0.8	3.4
TPMH160302-LP	L		●	★	★	9.525	3.18	0.2	4.4
TPMH160304-LP	L		●	★	★	9.525	3.18	0.4	4.4
TPMH160308-LP	L		●	★	★	9.525	3.18	0.8	4.4
TPMX090202-SW	L		●	●	●	5.56	2.38	0.2	2.9
TPMX090204-SW	L		●	●	●	5.56	2.38	0.4	2.9
TPMX090208-SW	L		●	●	●	5.56	2.38	0.8	2.9
TPMX110302-SW	L		●	●	●	6.35	3.18	0.2	3.4
TPMX110304-SW	L		●	●	●	6.35	3.18	0.4	3.4
TPMX110308-SW	L		●	●	●	6.35	3.18	0.8	3.4

1/2

(10 inserts in one case)



TPMH, TPMX – 11° POSITIVE INSERTS (WITH HOLE)

Order number			MC6115	MC6125	MC6135	IC	S	RE	D1
	M								
TPMH080202-MV	M			●	★	4.76	2.38	0.2	2.4
TPMH080204-MV	M			●	★	4.76	2.38	0.4	2.4
TPMH090202-MV	M			●	★	5.56	2.38	0.2	2.9
TPMH090204-MV	M			●	★	5.56	2.38	0.4	2.9
TPMH090208-MV	M			●	★	5.56	2.38	0.8	2.9
TPMH110302-MV	M			●	★	6.35	3.18	0.2	3.4
TPMH110304-MV	M			●	★	6.35	3.18	0.4	3.4
TPMH110308-MV	M			●	★	6.35	3.18	0.8	3.4
TPMH160304-MV	M			●	★	9.525	3.18	0.4	4.4
TPMH160308-MV	M			★	★	9.525	3.18	0.8	4.4

2/2

[10 inserts in one case]



WPMT

11° POSITIVE INSERTS (WITH HOLE)

M Class

WPMT



MV

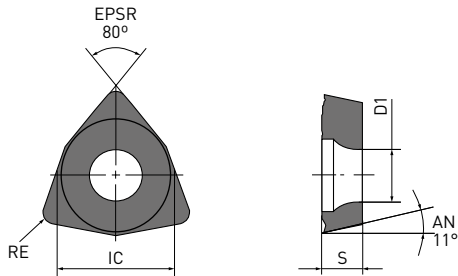

Order number			MC6115	MC6125	MC6135	IC	S	RE	D1
	M	M							
WPMT040202-MV		M		●	★	6.35	2.38	0.2	2.8
WPMT040204-MV		M		★	★	6.35	2.38	0.4	2.8
WPMT060304-MV		M		★	★	9.525	3.18	0.4	4.4
WPMT060308-MV		M		●	★	9.525	3.18	0.8	4.4

1/1

[10 inserts in one case]



SPMR, SPMN

11° POSITIVE INSERTS (WITHOUT HOLE)

M Class

SPMR, SPMN

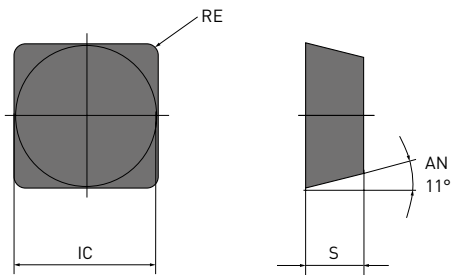

Standard Flat Top



Order number			MC6115	MC6125	MC6135	IC	S	RE	D1
	F	L							
SPMR090304		M	★	★	★	9.525	3.18	0.4	—
SPMR090308		M	●	★	★	9.525	3.18	0.8	—
SPMR120304		M	●	★	★	12.7	3.18	0.4	—
SPMR120308		M	●	★	★	12.7	3.18	0.8	—
SPMN090308		—	★			9.525	3.18	0.8	—
SPMN120304		—	★			12.7	3.18	0.4	—
SPMN120308		—	●			12.7	3.18	0.8	—
SPMN120312		—	●		★	12.7	3.18	1.2	—

1/1

(10 inserts in one case)





TPMR, TPMN

11° POSITIVE INSERTS (WITHOUT HOLE)

M Class

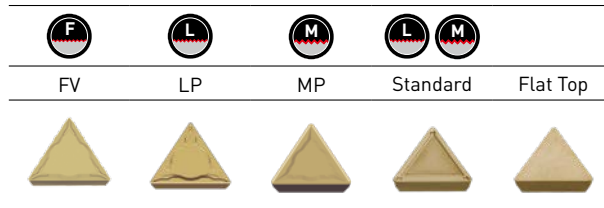
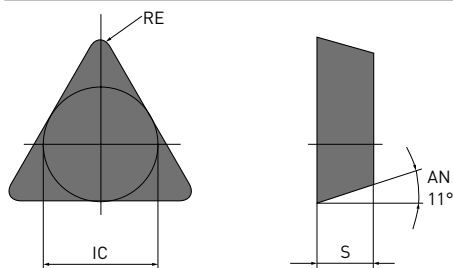
TPMR, TPMN



Order number			MC6115	MC6125	MC6135	IC	S	RE	D1
									
TPMR160304-FV	F			●	●	9.525	3.18	0.4	—
TPMR110304-LP	L			●	●	6.35	3.18	0.4	—
TPMR110308-LP	L			●	●	6.35	3.18	0.8	—
TPMR160304-LP	L		●	●	●	9.525	3.18	0.4	—
TPMR160308-LP	L		●	●	●	9.525	3.18	0.8	—
TPMR110304-MP	M		●	●	●	6.35	3.18	0.4	—
TPMR110308-MP	M		●	●	●	6.35	3.18	0.8	—
TPMR160304-MP	M		●	●	●	9.525	3.18	0.4	—
TPMR160308-MP	M		●	●	●	9.525	3.18	0.8	—
TPMR110304	M		●	★	★	6.35	3.18	0.4	—
TPMR110308	M		●	★	★	6.35	3.18	0.8	—
TPMR160304	M		●	★	★	9.525	3.18	0.4	—
TPMR160308	M		●	★	★	9.525	3.18	0.8	—
TPMR160312	M		●	★		9.525	3.18	1.2	—
TPMN110304	—		●			6.35	3.18	0.4	—
TPMN110308	—		★			6.35	3.18	0.8	—
TPMN160304	—		●			9.525	3.18	0.4	—
TPMN160308	—		●			9.525	3.18	0.8	—
TPMN160312	—		★			9.525	3.18	1.2	—
TPMN220404	—		★			12.7	4.76	0.4	—
TPMN220408	—		★		★	12.7	4.76	0.8	—
TPMN220412	—		★			12.7	4.76	1.2	—

1/1



(10 inserts in one case)



MC6100 SERIES

RECOMMENDED CUTTING CONDITIONS

NEGATIVE INSERTS (FOR EXTERNAL TURNING)

Material	Properties	Conditions			Priority	Grade		Vc	f	ap
			F	L						
Mild steel	≤180 HB	+	F	1	MC6125	FY	385 – 605	0.09 – 0.23	0.20 – 0.80	
		+	F	2	MC6135	FY	315 – 480	0.09 – 0.23	0.20 – 0.80	
		+	L	1	MC6125	SY	350 – 550	0.16 – 0.33	0.50 – 1.20	
		+	L	2	MC6135	SY	290 – 435	0.16 – 0.33	0.50 – 1.20	
Carbon and alloy steel	180 – 280 HB	●	F	1	MC6115	FPH	275 – 525	0.20 – 0.50	0.10 – 1.00	
		●	F	1	MC6115	FP	250 – 480	0.08 – 0.25	0.10 – 1.00	
		●	F	2	MC6125	FP	275 – 425	0.08 – 0.25	0.10 – 1.00	
		●	L	1	MC6115	LP	250 – 480	0.10 – 0.40	0.30 – 2.00	
		●	L	2	MC6125	LP	275 – 425	0.10 – 0.40	0.30 – 2.00	
		●	L	3	MC6115	SH	250 – 480	0.10 – 0.40	0.30 – 2.00	
		●	L	4	MC6125	SH	275 – 425	0.10 – 0.40	0.30 – 2.00	
		●	L	5	MC6115	SA	250 – 480	0.10 – 0.40	0.30 – 2.00	
		●	L	6	MC6125	SA	275 – 425	0.10 – 0.40	0.30 – 2.00	
		●	L	7	MC6115	SW	250 – 480	0.10 – 0.50	0.30 – 2.50	
		●	L	8	MC6125	SW	275 – 425	0.10 – 0.50	0.30 – 2.50	
		●	M	1	MC6115	MP	230 – 440	0.16 – 0.50	0.30 – 4.00	
		●	M	2	MC6125	MP	250 – 390	0.16 – 0.50	0.30 – 4.00	
		●	M	3	MC6115	MA	230 – 440	0.20 – 0.50	0.30 – 4.00	
		●	M	4	MC6125	MA	250 – 390	0.20 – 0.50	0.30 – 4.00	
		●	M	5	MC6115	Std	230 – 440	0.25 – 0.60	1.50 – 5.00	
		●	M	6	MC6125	Std	250 – 390	0.25 – 0.60	1.50 – 5.00	
		●	M	7	MC6115	MW	230 – 440	0.20 – 0.60	0.90 – 4.00	
		●	M	8	MC6125	MW	250 – 390	0.20 – 0.60	0.90 – 4.00	
		●	R	1	MC6115	RP	215 – 415	0.25 – 0.60	1.50 – 6.00	
		●	R	2	MC6125	RP	235 – 370	0.25 – 0.60	1.50 – 6.00	
		●	R	3	MC6115	GH	215 – 415	0.25 – 0.60	1.50 – 6.00	
		●	R	4	MC6125	GH	235 – 370	0.25 – 0.60	1.50 – 6.00	
		●	H	1	MC6125	HX	210 – 330	0.50 – 1.26	3.00 – 11.00	
●	H	2	MC6135	HX	170 – 260	0.50 – 1.26	3.00 – 11.00			
●	H	3	MC6125	HV	175 – 270	0.58 – 1.26	4.00 – 12.00			
●	H	4	MC6135	HV	140 – 215	0.58 – 1.26	4.00 – 12.00			































1/3

1. Recommended cutting conditions for 5°/7°/11° positive inserts are provided as a guideline only. Verify the recommended conditions for each boring bar as cutting conditions for internal machining will vary depending on the length of overhang.

MC6100 SERIES

RECOMMENDED CUTTING CONDITIONS

NEGATIVE INSERTS (FOR EXTERNAL TURNING)

Material	Properties	Conditions			Priority	Grade		Vc	f	ap
P Carbon and alloy steel	180 – 280 HB		F	1	MC6125	FPH	300 – 465	0.20 – 0.50	0.10 – 1.00	
			F	1	MC6115	FP	250 – 480	0.08 – 0.25	0.10 – 1.00	
			F	2	MC6125	FP	275 – 425	0.08 – 0.25	0.10 – 1.00	
			L	1	MC6115	LP	250 – 480	0.10 – 0.40	0.30 – 2.00	
			L	2	MC6125	LP	275 – 425	0.10 – 0.40	0.30 – 2.00	
			L	3	MC6115	SH	250 – 480	0.10 – 0.40	0.30 – 2.00	
			L	4	MC6125	SH	275 – 425	0.10 – 0.40	0.30 – 2.00	
			L	5	MC6115	SA	250 – 480	0.10 – 0.40	0.30 – 2.00	
			L	6	MC6125	SA	275 – 425	0.10 – 0.40	0.30 – 2.00	
			L	7	MC6115	SW	250 – 480	0.10 – 0.50	0.30 – 2.50	
			L	8	MC6125	SW	275 – 425	0.10 – 0.50	0.30 – 2.50	
			M	1	MC6125	MP	250 – 390	0.16 – 0.50	0.30 – 4.00	
			M	2	MC6135	MP	205 – 310	0.16 – 0.50	0.30 – 4.00	
			M	3	MC6125	MA	250 – 390	0.20 – 0.50	0.30 – 4.00	
			M	4	MC6135	MA	205 – 310	0.20 – 0.50	0.30 – 4.00	
			M	5	MC6125	MH	250 – 390	0.20 – 0.55	1.00 – 4.00	
			M	6	MC6135	MH	205 – 310	0.20 – 0.55	1.00 – 4.00	
			M	7	MC6125	Std	250 – 390	0.25 – 0.60	1.50 – 5.00	
			M	8	MC6135	Std	205 – 310	0.25 – 0.60	1.50 – 5.00	
			M	9	MC6125	MW	250 – 390	0.20 – 0.60	0.90 – 4.00	
			M	10	MC6135	MW	205 – 310	0.20 – 0.60	0.90 – 4.00	
			R	1	MC6135	RP	190 – 290	0.25 – 0.60	1.50 – 6.00	
			R	2	MC6125	RP	235 – 370	0.25 – 0.60	1.50 – 6.00	
			R	3	MC6135	GH	190 – 290	0.25 – 0.60	1.50 – 6.00	
			R	4	MC6125	GH	235 – 370	0.25 – 0.60	1.50 – 6.00	
			H	1	MC6135	HX	170 – 260	0.50 – 1.26	3.00 – 11.00	
			H	2	MC6125	HX	210 – 330	0.50 – 1.26	3.00 – 11.00	
			H	3	MC6135	HV	140 – 215	0.58 – 1.26	4.00 – 12.00	
	H	4	MC6125	HV	175 – 270	0.58 – 1.26	4.00 – 12.00			



2/3

1. Recommended cutting conditions for 5°/7°/11° positive inserts are provided as a guideline only. Verify the recommended conditions for each boring bar as cutting conditions for internal machining will vary depending on the length of overhang.

MC6100 SERIES

RECOMMENDED CUTTING CONDITIONS

NEGATIVE INSERTS (FOR EXTERNAL TURNING)

Material	Properties	Conditions			Priority	Grade		Vc	f	ap
			F	L						
P Carbon and alloy steel	180 – 280 HB	+	F	1	MC6135	FP	245 – 370	0.08 – 0.25	0.10 – 1.00	
		+	F	2	MC6125	FP	300 – 465	0.08 – 0.25	0.10 – 1.00	
		+	F	3	MC6135	FPH	245 – 370	0.20 – 0.50	0.10 – 1.00	
		+	L	1	MC6135	LP	225 – 340	0.10 – 0.40	0.30 – 2.00	
		+	L	2	MC6125	LP	275 – 425	0.10 – 0.40	0.30 – 2.00	
		+	L	3	MC6135	SH	225 – 340	0.10 – 0.40	0.30 – 2.00	
		+	L	4	MC6125	SH	275 – 425	0.10 – 0.40	0.30 – 2.00	
		+	L	5	MC6135	SA	225 – 340	0.10 – 0.40	0.30 – 2.00	
		+	L	6	MC6125	SA	275 – 425	0.10 – 0.40	0.30 – 2.00	
		+	M	1	MC6135	MP	205 – 310	0.16 – 0.50	0.30 – 4.00	
		+	M	2	MC6125	MP	250 – 390	0.16 – 0.50	0.30 – 4.00	
		+	M	3	MC6135	MA	205 – 310	0.20 – 0.50	0.30 – 4.00	
		+	M	4	MC6125	MA	250 – 390	0.20 – 0.50	0.30 – 4.00	
		+	M	5	MC6135	MH	205 – 310	0.20 – 0.55	1.00 – 4.00	
		+	M	6	MC6125	MH	250 – 390	0.20 – 0.55	1.00 – 4.00	
		+	M	7	MC6135	Std	205 – 310	0.25 – 0.60	1.50 – 5.00	
		+	M	8	MC6125	Std	250 – 390	0.25 – 0.60	1.50 – 5.00	
		+	M	9	MC6135	MW	205 – 310	0.20 – 0.60	0.90 – 4.00	
		+	M	10	MC6125	MW	250 – 390	0.20 – 0.60	0.90 – 4.00	
		+	R	1	MC6135	RP	190 – 290	0.25 – 0.60	1.50 – 6.00	
+	R	2	MC6125	RP	235 – 370	0.25 – 0.60	1.50 – 6.00			
+	R	3	MC6135	GH	190 – 290	0.25 – 0.60	1.50 – 6.00			
+	R	4	MC6125	GH	235 – 370	0.25 – 0.60	1.50 – 6.00			
+	H	1	MC6135	HX	170 – 260	0.50 – 1.26	3.00 – 11.00			
+	H	2	MC6125	HX	210 – 330	0.50 – 1.26	3.00 – 11.00			



3/3

1. Recommended cutting conditions for 5°/7°/11° positive inserts are provided as a guideline only. Verify the recommended conditions for each boring bar as cutting conditions for internal machining will vary depending on the length of overhang.

MC6100 SERIES

RECOMMENDED CUTTING CONDITIONS

5°, 7° POSITIVE INSERTS (FOR EXTERNAL TURNING)

Material	Properties	Conditions			Priority	Grade		Vc	f	ap
Mild steel	≤180 HB	●	F	1	MC6115	FP	295 – 570	0.04 – 0.20	0.20 – 0.90	
		●	F	2	MC6115	FV	295 – 570	0.04 – 0.20	0.20 – 0.90	
		●	L	1	MC6115	LP	295 – 570	0.06 – 0.25	0.20 – 1.00	
		●	L	2	MC6115	SW	295 – 570	0.06 – 0.24	0.20 – 1.50	
		●	M	1	MC6115	MP	245 – 475	0.08 – 0.30	0.30 – 2.00	
		●	M	2	MC6115	MV	245 – 475	0.08 – 0.30	0.30 – 2.00	
		●	M	3	MC6115	MW	245 – 475	0.10 – 0.35	0.80 – 2.50	
		✚	F	1	MC6125	FP	320 – 505	0.04 – 0.20	0.20 – 0.90	
		✚	F	2	MC6135	FP	265 – 400	0.04 – 0.20	0.20 – 0.90	
		✚	L	1	MC6125	LP	320 – 505	0.06 – 0.25	0.20 – 1.00	
		✚	L	2	MC6135	LP	265 – 400	0.06 – 0.25	0.20 – 1.00	
		✚	L	3	MC6125	SW	320 – 505	0.06 – 0.24	0.20 – 1.50	
		✚	M	1	MC6125	MP	270 – 420	0.08 – 0.30	0.30 – 2.00	
		✚	M	2	MC6135	MP	220 – 330	0.08 – 0.30	0.30 – 2.00	
		✚	M	3	MC6125	MV	270 – 420	0.08 – 0.30	0.30 – 2.00	
		Carbon and alloy steel	180 – 280 HB	●	F	1	MC6115	FP	220 – 420	0.04 – 0.20
●	F			2	MC6125	FP	240 – 370	0.04 – 0.20	0.20 – 0.90	
●	F			3	MC6115	FV	220 – 420	0.04 – 0.20	0.20 – 0.90	
●	L			1	MC6115	LP	220 – 420	0.06 – 0.25	0.20 – 1.00	
●	L			2	MC6125	LP	240 – 370	0.06 – 0.25	0.20 – 1.00	
●	M			1	MC6125	MP	200 – 310	0.08 – 0.30	0.30 – 2.00	
●	M			2	MC6115	MP	180 – 350	0.08 – 0.30	0.30 – 2.00	
●	M			3	MC6125	MV	200 – 310	0.08 – 0.30	0.30 – 2.00	
●	M			4	MC6115	MV	180 – 350	0.08 – 0.30	0.30 – 2.00	
●	M			5	MC6115	MW	180 – 350	0.10 – 0.35	0.80 – 2.50	
✚	F			1	MC6125	FP	240 – 370	0.04 – 0.20	0.20 – 0.90	
✚	F			2	MC6135	FP	195 – 295	0.04 – 0.20	0.20 – 0.90	
✚	F			3	MC6125	FV	240 – 370	0.04 – 0.20	0.20 – 0.90	
✚	L			1	MC6125	LP	240 – 370	0.06 – 0.25	0.20 – 1.00	
✚	L			2	MC6135	LP	195 – 295	0.06 – 0.25	0.20 – 1.00	
✚	L			3	MC6125	SW	240 – 370	0.06 – 0.24	0.20 – 1.50	
✚	M	1	MC6125	MP	200 – 310	0.08 – 0.30	0.30 – 2.00			
✚	M	2	MC6135	MP	160 – 245	0.08 – 0.30	0.30 – 2.00			
✚	M	3	MC6125	MV	200 – 310	0.08 – 0.30	0.30 – 2.00			

1/2



- Recommended cutting conditions for 5°/7°/11° positive inserts are provided as a guideline only. Verify the recommended conditions for each boring bar as cutting conditions for internal machining will vary depending on the length of overhang.
- Please scan the QR code for a pamphlet of the recommended conditions for the XCMT profile holder insert.



MC6100 SERIES

RECOMMENDED CUTTING CONDITIONS

5° 7° POSITIVE INSERTS (FOR EXTERNAL TURNING)

Material	Properties	Conditions			Priority	Grade		Vc	f	ap
P Carbon and alloy steel	280 – 350 HB	●	F	1	MC6115	FP	155 – 295	0.04 – 0.20	0.20 – 0.90	
		●	F	2	MC6115	FV	155 – 295	0.04 – 0.20	0.20 – 0.90	
		●	L	1	MC6115	LP	155 – 295	0.06 – 0.25	0.20 – 1.00	
		●	M	1	MC6115	MP	130 – 245	0.08 – 0.30	0.30 – 2.00	
		●	M	2	MC6115	MV	130 – 245	0.08 – 0.30	0.30 – 2.00	
		✚	F	1	MC6125	FP	170 – 265	0.04 – 0.20	0.20 – 0.90	
		✚	F	2	MC6135	FP	135 – 210	0.04 – 0.20	0.20 – 0.90	
		✚	L	1	MC6125	LP	170 – 265	0.06 – 0.25	0.20 – 1.00	
		✚	L	2	MC6135	LP	135 – 210	0.06 – 0.25	0.20 – 1.00	
		✚	M	1	MC6125	MP	140 – 220	0.08 – 0.30	0.30 – 2.00	
		✚	M	2	MC6135	MP	115 – 175	0.08 – 0.30	0.30 – 2.00	
		✚	M	3	MC6125	MV	140 – 220	0.08 – 0.30	0.30 – 2.00	

2/2



- Recommended cutting conditions for 5°/7°/11° positive inserts are provided as a guideline only. Verify the recommended conditions for each boring bar as cutting conditions for internal machining will vary depending on the length of overhang.
- Please scan the QR code for a pamphlet of the recommended conditions for the XCMT profile holder insert.



MC6100 SERIES

RECOMMENDED CUTTING CONDITIONS

11° POSITIVE INSERTS (FOR EXTERNAL TURNING)

Material	Properties	Conditions			Priority	Grade		Vc	f	ap
			F	L						
Mild steel	≤180 HB	●	F	1	MC6125	FP	320 – 505	0.04 – 0.20	0.20 – 0.90	
		●	F	2	MC6125	FV	320 – 505	0.04 – 0.20	0.20 – 0.90	
		●	L	1	MC6125	LP	320 – 505	0.06 – 0.25	0.20 – 1.00	
		●	L	2	MC6115	R-Std	245 – 475	0.08 – 0.30	0.30 – 2.00	
		●	M	1	MC6125	MP	270 – 420	0.08 – 0.30	0.30 – 2.00	
		●	M	2	MC6115	MP	245 – 475	0.08 – 0.30	0.30 – 2.00	
		●	M	3	MC6125	MV	270 – 420	0.08 – 0.30	0.30 – 2.00	
		●	M	4	MC6115	MV	245 – 475	0.08 – 0.30	0.30 – 2.00	
		✚	L	1	MC6125	LP	320 – 505	0.06 – 0.25	0.20 – 1.00	
		✚	L	2	MC6135	LP	245 – 400	0.06 – 0.25	0.20 – 1.00	
		✚	M	1	MC6125	MP	270 – 420	0.08 – 0.30	0.30 – 2.00	
		✚	M	2	MC6135	MP	220 – 330	0.08 – 0.30	0.30 – 2.00	
		✚	M	3	MC6125	MV	270 – 420	0.08 – 0.30	0.30 – 2.00	
		✚	M	4	MC6135	MV	220 – 330	0.08 – 0.30	0.30 – 2.00	
Carbon and alloy steel	180 – 280 HB	●	F	1	MC6125	FP	240 – 370	0.04 – 0.20	0.20 – 0.90	
		●	F	2	MC6125	FV	240 – 370	0.04 – 0.20	0.20 – 0.90	
		●	L	1	MC6125	LP	240 – 370	0.06 – 0.25	0.20 – 1.00	
		●	L	2	MC6115	LP	220 – 420	0.06 – 0.25	0.20 – 1.00	
		●	M	1	MC6125	MP	200 – 310	0.08 – 0.30	0.30 – 2.00	
		●	M	2	MC6125	MV	200 – 310	0.08 – 0.30	0.30 – 2.00	
		●	M	3	MC6115	R-Std	180 – 350	0.08 – 0.30	0.30 – 2.00	
		●	M	4	MC6125	R-Std	200 – 310	0.08 – 0.30	0.30 – 2.00	
		✚	L	1	MC6125	LP	240 – 370	0.06 – 0.25	0.20 – 1.00	
		✚	L	2	MC6135	LP	195 – 295	0.06 – 0.25	0.20 – 1.00	
		✚	M	1	MC6125	MP	200 – 310	0.08 – 0.30	0.30 – 2.00	
		✚	M	2	MC6135	MP	160 – 245	0.08 – 0.30	0.30 – 2.00	
		✚	M	3	MC6125	MV	200 – 310	0.08 – 0.30	0.30 – 2.00	
		✚	M	4	MC6135	MV	160 – 245	0.08 – 0.30	0.30 – 2.00	

1/1

MC6115

APPLICATION EXAMPLES

Tool	WNMG080412-MP
Material	DIN 20MnCr5
Component	Machine parts
Application	Face turning
Vc (m/min)	235
f (mm/rev)	0.35
ap (mm)	1.0
Cutting mode	Wet cutting

Results MC6115 achieved long tool life with excellent wear resistance and stable cutting, compared to a conventional product.

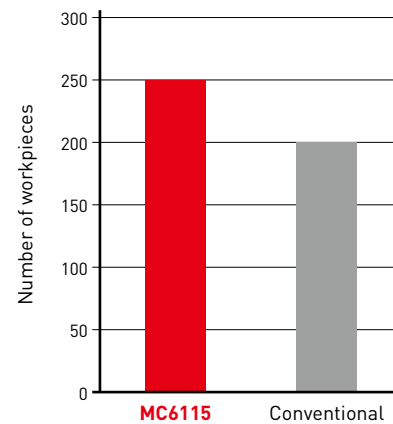

Tool	WNMG080408-MP
Material	DIN 41Cr4
Component	Hub
Application	External turning and facing
Vc (m/min)	300
f (mm/rev)	0.25-0.35
ap (mm)	1-2.5
Cutting mode	Wet cutting

Results Superior wear resistance means tool life was extended when compared to conventional products.

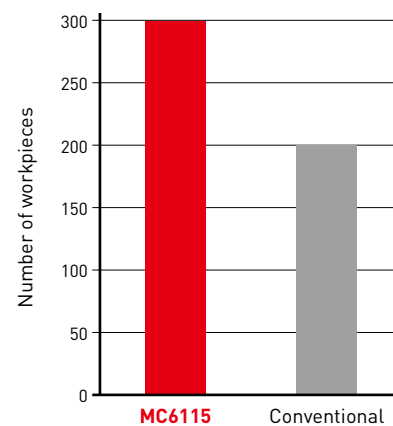
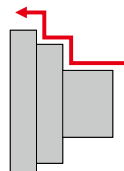

Tool	DNMG150612-SA
Material	Bearing steel
Component	Bearing parts
Application	External turning and facing
Vc (m/min)	260
f (mm/rev)	0.3-0.35
ap (mm)	0.5
Cutting mode	Wet cutting

Results Extreme resistance to chipping achieved 150 % tool life and enabled easy identification of worn edges.

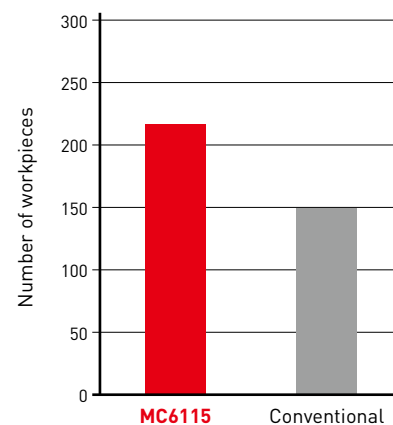
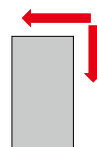

The examples shown are customer's applications, therefore can differ from the recommended conditions.

MC6125

APPLICATION EXAMPLES

Tool	CNMG120408-MA
Material	C45
Component	Hex bar parts
Application	Interrupted finish turning
Vc (m/min)	150
f (mm/rev)	0.2
ap (mm)	2.0, 1.6
Cutting mode	Wet cutting

Results

Conventional products fractured after chipping but MC6125 formed ideal chip shapes and achieved a longer tool life.

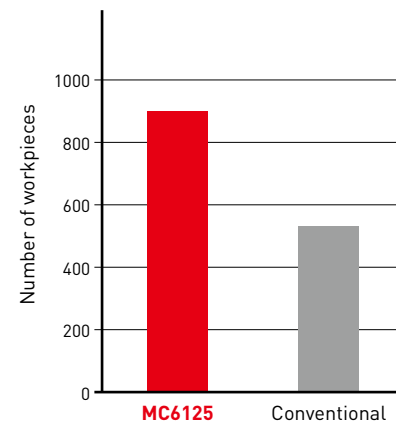
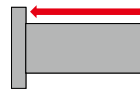

Tool	DNMG150412-SH
Material	DIN C50E
Application	Interrupted finish turning
Vc (m/min)	200
f (mm/rev)	0.3
ap (mm)	1.2
Cutting mode	Wet cutting

Results

MC6125 provided a stable cutting action and achieved 1.5 times more tool life than conventional products.

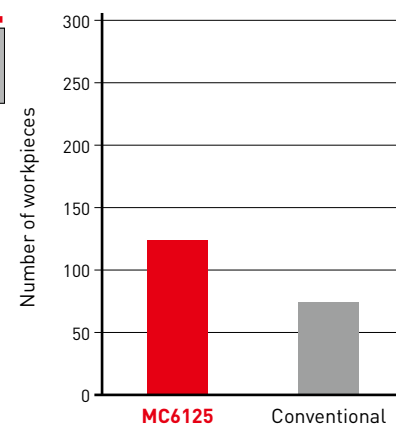

Tool	CNMG120412-RP
Material	DIN 34CrMo4
Component	Flange parts
Application	External turning and facing
Vc (m/min)	200
f (mm/rev)	0.25
ap (mm)	1.5
Cutting mode	Wet cutting

Results

Conventional products machined an inconsistent number of components. MC6125 was more consistent and improved tool life.

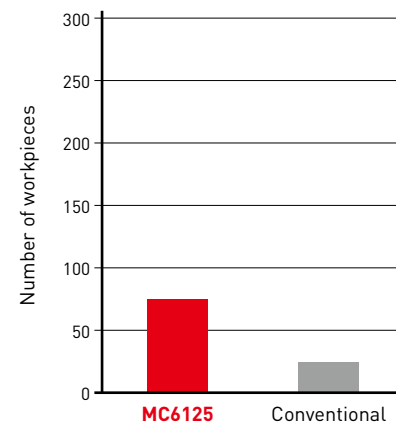
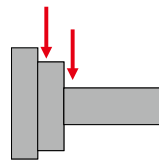

The examples shown are customer's applications, therefore can differ from the recommended conditions.

EUROPEAN SALES COMPANIES

GERMANY

MMC HARTMETALL GMBH
Comeniusstr. 2 . 40670 Meerbusch
Phone +49 2159 91890 . Fax +49 2159 918966
Email admin@mmchg.de

UK Office

MMC HARDMETAL UK LTD
1 Centurion Court, Centurion Way
Tamworth, B77 5PN
Phone +44 1827 312312
Email enquiries@mitsubishicarbide.co.uk

UK Deliveries/Returns

Unit 4 B5K Business Park, Quartz Close
Tamworth, B77 4GR

SPAIN

MITSUBISHI MATERIALS ESPAÑA, S.A.
Calle Emperador 2 . 46136 Museros/Valencia
Phone +34 96 1441711
Email comercial@mmevalencia.es

FRANCE

MMC METAL FRANCE S.A.R.L.
6, Rue Jacques Monod . 91400 Orsay
Phone +33 1 69 35 53 53 . Fax +33 1 69 35 53 50
Email mmfsales@mmc-metal-france.fr

POLAND

MMC HARDMETAL POLAND SP. Z O.O
Al. Armii Krajowej 61 . 50-541 Wrocław
Phone +48 71335 1620 . Fax +48 71335 1621
Email sales@mitsubishicarbide.com.pl

ITALY

MMC ITALIA S.R.L.
Viale Certosa 144 . 20156 Milano
Phone +39 0293 77031 . Fax +39 0293 589093
Email info@mmc-italia.it

TURKEY

MMC HARTMETALL GMBH ALMANYA - İZMİR MERKEZ ŞUBESİ
Adalet Mahallesi Anadolu Caddesi No: 41-1 . 15001 35530 Bayraklı / İzmir
Phone +90 232 5015000 . Fax +90 232 5015007
Email info@mmchg.com.tr

www.mmc-carbide.com

DISTRIBUTED BY:

□

□

L

┘

B266E 